



BARRISOL®

STRETCH CEILINGS



Stephen PRICE-BATES, Designer Consultants



Architect : Hakan KIRAN



Designer : II by V



Architect: Peter EISENMANN

TECHNICAL DOCUMENTATION



BARRISOL TECHNICAL DOCUMENTATION

*Welcome to the Barrisol Universe
The Art of Stretch Ceilings
introducing Barrisol creations*



THE QUALITY OF BARRISOL MATERIALS

THE EXCELLENCE OF THE STRETCH CEILING SYSTEMS

THE MANUFACTURING AND INSTALLATION TECHNIQUES

"THE BARRISOL KNOW-HOW"

**A NATIONAL AND INTERNATIONAL NETWORK OF BARRISOL
DISTRIBUTORS AT YOUR DISPOSAL**

**ALL CONTRIBUTE TO THE
BEAUTY OF BARRISOL UNIVERSE CEILINGS**



<p>WELCOME TO THE WORLD OF BARRISOL</p> <p>Chapter 1</p>	<p>Editorial p 4 List of awards p 5 Barrisol projects p 6 & 7 The manufacturer Barrisol in France and around the world p 9 Safety p 10</p>	
<p>PERIMETER TRACKS AND FINISHES</p> <p>Chapter 2</p>	<p>Barrisol components p 11 Barrisol finishes p 12 & 19 Technical specifications p 20 Examples of projects p 21 Tracks and rails p 22 & 23</p>	
<p>SELECTING BARRISOL CLASSIC PVC AND BARRISOL STAR ALUMINIUM TRACKS</p> <p>Chapter 3</p>	<p>Criteria for use p 24 to 27 Where to use them p 28 & 29 General installation conditions p 30</p>	
<p>BARRISOL CLASSIC VISIBLE PVC TRACKS</p> <p>Chapter 4</p>	<p>The Barrisol Classic system p 31 Barrisol Classic tracks p 32</p>	
<p>BARRISOL STAR SEMI-CONCEALED ALUMINIUM TRACKS</p> <p>Chapter 5</p>	<p>The Barrisol Star system p 33 Barrisol Star tracks p 34</p>	
<p>BARRISOL CLASSIC AND STAR: FIXING DETAILS</p> <p>Chapter 6</p>	<p>Cornices and beams p 35 Around pipes, pillars, columns p 36 Duo Barrisol Star incorporating logos – design features p 37 Various types of embedding p 38 Technical details p 39</p>	
<p>BARRISOL CLASSIC AND STAR: MULTIPLE SLOPES</p> <p>Chapter 7</p>	<p>Barrisol Classic sloping ceiling systems p 40 Barrisol Star sloping ceiling systems p 41 Stretch ceilings with recesses p 42</p>	
<p>BARRISOL STAR 3D</p> <p>Chapter 8</p>	<p>The Barrisol Star 3D stretch ceiling p 43 Barrisol Star 3D tracks p 44</p>	
<p>BARRISOL AND LARGE AREAS</p> <p>Chapter 9</p>	<p>Large Barrisol areas p 45 Barrisol Classic and Barrisol Star separators p 46 The Barrisol Super Star separator, support separators, braid systems p 47 Light strip separators p 48 Ceiling installations in large areas p 49 Design and separators p 50</p>	
<p>BARRISOL AND LIGHTING</p> <p>Chapter 10</p>	<p>Barrisol Universe spots p 51 Barrisol spot supports p 52 The Barrispot system p 53 Barrisol light boxes p 54 Suspended lighting, light supports, optical fibres and mini-spots p 55 Indirect flood lights p 56 Simulated glass roof p 57 Barrisol for all lighting types p 58 Examples of projects p 59</p>	
<p>BARRISOL ACOUSTIC</p> <p>Chapter 11</p>	<p>Barrisol MicroAcoustic p 60 & 61 Barrisol p 62 Barrisol Miniperf p 63</p>	
<p>TECHNICAL SPECIFICATION FOR INVITATION TO TENDER</p> <p>Chapter 12</p>	<p>Barrisol specification USA p 64 to 67 Barrisol Star UK K40 p 68 Barrisol Trempo UK K40 p 69 Barrisol-Microperf UK K40 p 70</p>	
<p>PHOTOS OF BARRISOL TRACKS</p> <p>Chapter 13</p>	<p>Attachment tracks for Barrisol stretch ceilings p 71 to 81</p>	

EDITORIAL

Some 30 years ago, under the impetus of Jacques Mattern, an architect at Montbéliard, to whom I would like to give homage here, I launched into the great adventure of stretch ceilings. Today, I am delighted and proud that the dynamism set in motion at that time helped us develop, year after year, all the technical progress in stretch ceilings and create a wide range of Barrisol systems which now make up the complete solution.

After being the first to create the M1 (Class 0, Class 1) stretch ceiling, that can be disassembled and reassembled as required, we continued our action based on the principles of safety, performance, technology, efficiency, aesthetics, in the aim of installation quality, resistance and durability, along with customer service and satisfaction.

We have designed products in compliance with safety and environment standards, created and developed a large number of Barrisol stretch ceiling systems, including the renowned Barrisol Star with invisible tracks. We have brought these products to an exceptional technical and aesthetic level.

This enables us to offer architects and designers a wide variety of expressions, so they can incorporate Barrisol in the range of their products, giving superb results. With the Barrisol team, we are delighted to introduce you to Barrisol technology.

Fernand SCHERRER

CEO of NORMALU
Inventor of BARRISOL

BARRISOL: QUALITY AT THE SERVICE OF CUSTOMERS

- Using the best products in compliance with the most stringent standards.
- Unique manufacturing quality (over fifteen tests and inspections performed throughout the order processing, production and shipment process).
- Customised manufacturing lead times to meet customers' needs.
- A technical department offering the most suitable solutions, in economical and technical terms.
- An efficient after-sales services.
- A research and development department willing to listen to your needs for all types of refurbishing and new projects.



THE MOST AWARD-WINNING CEILING IN THE WORLD

MEMBER OF THE CLUB



OF THE WORLD N° 1 FOR EXPORTS



INNOVATION PRIZE 2002
ARCHITECTURE + PRESENTATION
BARRISOL-MICROSORBER
DUSSELDORF - GERMANY



INNOVATION PRIZE 2002
ARCHITECTURE + TECHNOLOGY
BARRISOL LUMIERE
FRANKFURT - GERMANY



AVANT-GARDE PRODUCT 2001
PLZEN - CZECH REPUBLIC



GOLD MEDAL 2001
BUCAREST - RUMANIA



BEST PRODUCT AWARD 2001
OLSZTYN - POLAND



INNOVATION AND QUALITY 2000
WARSAW - POLAND



PAINTERS ASSOCIATION
INNOVATION + TECHNOLOGY 2000
BERLIN - GERMANY

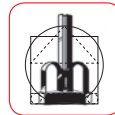

EXCELLENCE AWARD 1999
CANADA



CONSTRUCTION
EXCELLENCE AWARD 1998
CISCA - USA



THE HIGHEST PERFORMANCE
AND QUALITY 1997
RENDEZ-VOUS HOTEL-RESTAURANT - CANADA



HONOURABLE MENTION 1997
'97 ESPACIOS - CHILE



GOLD MEDAL 1996
DECOR EXPO '96 CHINA

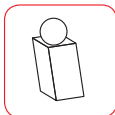

PRIZE FOR INNOVATION 1996
INTERBUILD MELBOURNE - AUSTRALIA

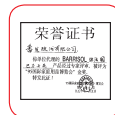

GOLD MEDAL PRODUCT AWARD
1995
CHINA



GOLD MEDAL PRODUCT AWARD 1995
CONECO '95 - CZECH REPUBLIC



FIRST PRIZE FOR PRODUCT
AND TECHNOLOGY 1993
ARCH '93 PRAGUE - CZECH REPUBLIC



BRONZE MEDAL FOR
INNOVATION 1991
BATIMAT PARIS - FRANCE



SNAI HONORARY OSCAR
BARRISOL STAR 1991
NATIONAL FEDERATION OF INTERIOR
ARCHITECTS - FRANCE

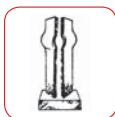

"THE EXCEPTIONAL" AWARD 1990
GENEVA - SWITZERLAND



SPECIAL JURY AWARD FOR
THERMALU-BARRISOL 1990
GRENOBLE - FRANCE



SNAI OSCAR 1985
NATIONAL FEDERATION OF INTERIOR
ARCHITECTS - FRANCE

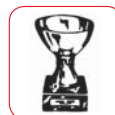

AVANT-GARDE PRODUCT
AWARD 1984
FRANCE



LABEL OF INDUSTRIAL
AESTHETICS 1983
FORMES ET INDUSTRIE - FRANCE



SILVER MEDAL
FOR INNOVATION 1975
BATIMAT - FRANCE

BARRISOL PRESENTS

20 STRETCH CEILING

STRETCH WALL

STAND ALONE STRETCH STRUCTURE

SYSTEMS

These systems offer a choice of products adapted to each situation and each design for an aesthetic result.

The technology is tried-and-tested, reliable, in compliance with safety standards; the materials used are of the highest quality, the finishes exact and precise.

SYSTEMS

Definition

BARRISOL CLASSIC

The ceiling stretched from wall to wall on visible track.

BARRISOL STAR

The ceiling stretched from wall to wall or ceiling on invisible peripheral track

BARRISOL STAR 3D

The structured stretch ceiling with 3D architectural lines

BARRISOL LARGE SURFACES

Visible, flash gap joint, invisible or luminous track separators for the subdivision of large surfaces.

BARRISOL STAR CREAFORM

Creation of 3D shapes to be integrated into Barrisol ceilings
Creation of stand alone shapes.

BARRIMUR STAR WALL

Stretch walls on Barrisol Star wall tracks

BARRISOL STAR MODULAR

Structure-mounted or suspended self-supporting modular panels, with variable heights and angles



BARRISOL SYSTEMS

(Continued)

BARRISOL TREMPO

Barrisol stretched fabric connected by elastic cord to Barrisol Trempo peripheral tracks.

BARRISOL CEILING TILES

Barrisol stretched fabric in ceiling tile form to be mounted on metal rails

BARRISOL SIGN

For signs on large and middle-sized surfaces.

BARRISOL LIGHT

Light source integration technology in Barrisol stretch ceilings

BARRISOL ACOUSTIC

Barrisol Classic or Barrisol Star stretch ceiling complex combined with a sound absorbing material.

BARRISOL THERMAL

Barrisol Classic or Barrisol Star stretch ceiling complex combined with a heat insulating material

BARRISOL AND ASBESTOS

Special system to confine asbestos in ceilings, with double protection and sealed tracks

BARRISOL FIREBREAK

Barrisol Classic stretch ceiling complex combined with fire-retardant materials.

BARRISOL SMOKE CLEARANCE

36/100 fabric with 10 mm diameter perforations to allow smoke clearance

BARRISOL CLEAN ROOMS

Stretch ceiling system for clean rooms with sealed tracks.

BARRISOL SYMA

Combination of Barrisol Star stretch ceilings and Syma aluminium structures.

BARRISOL THERMALU

Very low voltage backup heating stretch ceilings.

BARRISOL PAINTED DECOR

Painted Barrisol Universe stretch ceilings.
Painted Decor stretch walls and ceilings.
Painted Decor light boxes.

BARRISOL PRINTED DECOR

Printed decors on Barrisol fabrics.

BARRISOL - normalu S.A.S.



MEMBER OF THE CLUB OF THE WORLD N° 1

No. 150 / 1993

35 years of experience and innovation at the service of our customers

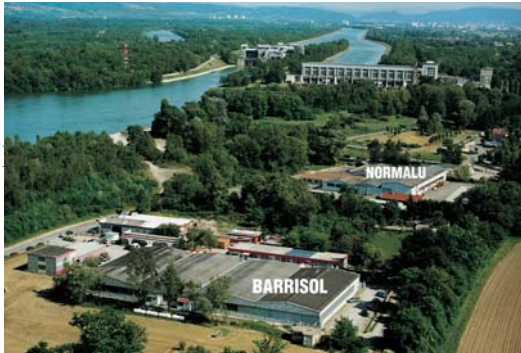

- ♦ **Date created: 1967**
- ♦ **Head office and distribution centre located in Kembs, near Germany and Switzerland, 10 minutes from the international Basel-Mulhouse-Freiburg airport**
- ♦ **Turnover: 20 million Euro/year**
- ♦ **150 employees**
- ♦ **CEO: Fernand Scherrer**

ACTIVITIES:

- ♦ **BARRISOL – stretch ceilings**

World leader in stretch ceilings, exclusive licensee for the BARRISOL brand and range of products

Manufacturer of Barrisol Universe stretch ceilings: Barrisol Classic, Barrisol Star, Barrisol Creaform, Barrisol Trempo, Barrisol Ceiling Tiles, Barrisol Wall, Barrisol Modular, Barrisol Sign

- ♦ **SYMA - SYSTEM**

Range of anodised or lacquered aluminium rails.

Manufacturer of removable partitions, exhibition stands, interior booths for museums and shops, interior fittings, machine cowling.

Exclusive French licensee for the SYMA brand and patents.

- ♦ **NORMARIDO – curtains for sports halls**

Manufacturer of separating curtains for sports halls.

PRODUCTION SITES: 13 500 m² :

- ♦ **Kembs: Normalu I** ≈ 6 000 m² (60,000 sqft) including :
 - ≈ 4 500 m² (45,000 sqft) - BARRISOL, ≈ 400 m² (4,000 sqft) - training facility,
 - ≈ 800 m² (8,000 sqft) - offices**Normalu II** ≈ 3 500 m² (35,000 sqft) - SYMA aluminium
- ♦ **Ste Marie aux Mines:** ≈ 4 000 m² (40,000 sqft) - BARRISOL - woodwork

SALES:

- ♦ **Kembs: licensing**
 - French sales network
 - International sales network
- ♦ **Bagneux :** ≈ 1 600 m² (16,000 sqft) including: ≈ 400 m² (4,000 sqft) of offices
≈ 400 m² (4,000 sqft) of showrooms ≈ 600 m² (6,000 sqft) of workshops
≈ 200 m² (2,000 sqft) of technical, sales and computer training

FILIALES :

- ♦ **THERMALU SARL:** ≈ 4 500 m² (45,000 sqft) - very low voltage backup heating for floors and ceilings
- ♦ **NORMALU EXPO:** Events organisation Salon Energie Habitat: 300 exhibitors
Salon Habitat Décoration: 150 exhibitors

Normalu S.A.S. Route du Sipes 68680 KEMBS - Tél. +33 (0)3.89.83.20.20 - Fax +33 (0)3.89.48.43.44 / +33 (0)3.89.48.45.95

Email: mail@barrisol.com - Website: www.barrisol.com



BARRISOL PRESENT ON 5 CONTINENTS

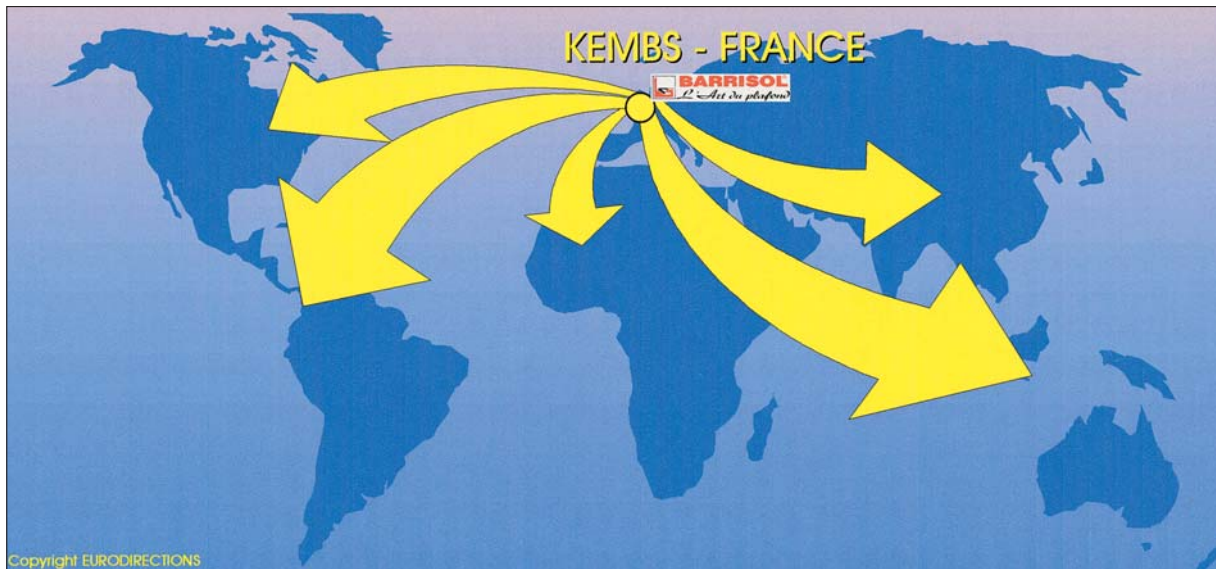

Worldwide: a network of 1200 approved installation specialists

- ♦ **Present:**
 - in all the countries of the European Union
 - in over 80 countries world-wide
- ♦ **over 25 000 000 sqm ≈ 250,000,000 sqft of BARRISOL ceilings installed around the world by approved companies:**

ALBANIA	EGYPT	LATVIA	SINGAPORE
ANDORRA	ESTONIA	LEBANON	SLOVAKIA
ARGENTINA	FINLAND	LIECHTENSTEIN	SLOVENIA
AUSTRALIA	FRANCE	LITHUANIA	SOUTH AFRICA
AUSTRIA	FRENCH OVERSEAS	LUXEMBOURG	SOUTH KOREA
AZERBAIJAN	DEPARTMENTS AND	MACEDONIA	SPAIN
BELGIUM	TERRITORIES	MALAYSIA	SWITZERLAND
BENIN	GEORGIA	MALTA	TAIWAN
BOSNIA	GERMANY	MAURITIUS	THAILAND
BRAZIL	GREAT BRITAIN	MEXICO	TOGO
BULGARIA	GREECE	MOLDAVIA	TUNISIA
CAMEROUN	HONG KONG	MOROCCO	TURKEY
CHILE	HUNGARY	NETHERLANDS	UKRAINE
CHINA	ICELAND	NEW CALEDONIA	UNITED ARAB
COLOMBIA	INDIA	NEW ZEALAND	EMIRATES
COSTA RICA	IRAN	PANAMA	UNITED STATES
CROATIA	IRELAND	POLAND	VATICAN
CUBA	ISRAEL	PORTUGAL	VENEZUELA
CYPRUS	ITALY	REPUBLIC OF	YUGOSLAVIA
CZECH REPUBLIC	JAPAN	BYELORUSSIA	Etc.
DENMARK	KAZAKHSTAN	RUMANIA	
DOMINICAN	KIRGHIZISTAN	RUSSIA	
REPUBLIC	KOSOVO	SAUDI ARABIA	
ECUADOR	KUWAIT	SENEGAL	

BARRISOL MEETS SAFETY STANDARDS

Barrisol creations always have one primary objective: safety. This requirement based on technological progress is confirmed by tests, certifications and authorisations from official French and international organisations.

FIRE CLASSIFICATION	<ul style="list-style-type: none"> ♦ Barrisol meets current international standards. ♦ Barrisol stretched fabrics: M1 in France (Paris Police Laboratory classification) – M1 in Belgium – B1 in Germany – Class 1 in Canada, USA, Italy – Class 0 in Great Britain. ♦ Peripheral tracks, cornices: PVC M1 – M0 aluminium ♦ Barrisol accessories: meet legal safety standards in the plenum: M0 and M1 classification
NON-TOXICITY	<ul style="list-style-type: none"> ♦ Barrisol's non-toxicity is confirmed by international tests: <ul style="list-style-type: none"> - United States Testing Company Inc Biological Services Division - International Maritime Organisation (IMO)
PUBLIC BUILDINGS	<ul style="list-style-type: none"> ♦ The French Ministry of the Interior has approved Barrisol in buildings receiving the public following tests conducted by the competent authorities ♦ Meets applicable standards in different countries
SPRINKLERS	<ul style="list-style-type: none"> ♦ Sprinklers can be built into Barrisol ceilings using suitable techniques according to applicable standards ♦ Barrisol Modular ceilings allow sprinkler openings for large surfaces
IN COMPLEX	<ul style="list-style-type: none"> ♦ Barrisol can be used in a fire-break complex with suitable materials.
SMOKE CLEARANCE	<ul style="list-style-type: none"> ♦ Barrisol fabric for smoke clearance, with 10 mm diameter perforations, is available in 36 colours.
SAFETY DEVICES	<ul style="list-style-type: none"> ♦ Remote surveillance cameras, emergency illumination and signage and all types of technical devices can be incorporated in Barrisol ceilings and walls using Barrisol techniques.
WATER DAMAGE	<ul style="list-style-type: none"> ♦ Barrisol is impermeable and helps prevent or minimise water damage.
MARINE	<ul style="list-style-type: none"> ♦ Barrisol is approved by Lloyds International.
FOOD HYGIENE	<ul style="list-style-type: none"> ♦ The National Centre for Veterinary and Food Studies of the French Ministry of Agriculture certifies that Barrisol complies with food hygiene requirements. ♦ The British Royal Health and Safety Institute certifies, after tests, that Barrisol meets hygiene standards perfectly. ♦ Greenall Food, a microbiology consultant, reported that after sterilisation Barrisol does not show bacterial growth.
FUNGICIDAL	<ul style="list-style-type: none"> ♦ By nature, Barrisol does not develop moulds or fungi.
SOUND-PROOFING	<ul style="list-style-type: none"> ♦ Soundproofing standard NF S31-003. ♦ Qualibat qualification No. 7152 ♦ Barrisol Acoustic complies with the technical recommendations of the French Ministry of Education for classrooms (APAVE Alsace) ♦ Absorption coefficient determined by the CSTB
GUARANTEE	<ul style="list-style-type: none"> ♦ Barrisol: 10-year manufacturer guarantee against all strip and harpoon seam manufacturing defects.
DURABILITY AND STABILITY	<ul style="list-style-type: none"> ♦ 30 years of experience demonstrate the high resistance of Barrisol ceilings which stay stretched and stable over time.



FABRICS AND TRACKS FOR BARRISOL UNIVERSE STRETCH CEILING SYSTEMS

**HIGH-QUALITY MATERIALS
OFFERING ADVANCED TECHNICAL PERFORMANCES,
CREATED FOR BARRISOL, MEETING BARRISOL
SAFETY, PERFORMANCE AND AESTHETIC CRITERIA**



BARRISOL FABRICS

M1 copolymer
cadmium-free
impermeable to water
shape and tension-retentive molecules
seams guaranteed 10 years
impermeable to fibres
impermeable to dust
return to their initial shape
after distortion
(e.g. water damage)

non-toxic
robust
recyclable
hygienic
fungicidal
sterilisable
insensitive to radiation
washable in 5 textures
allow disassembly and reassembly
as required

COULEURS
CLASSEMENT M1

COLOURS
CLASS 1 IN USA
CLASS 0 IN UK

FARBEN
KLASSE B1

COLORES
CLASE M1

CORES
CLASSE M1

COLORI
CLASSE 1

LES REFLETS LAQUÉS® - THE LACQUERS - DIE LACKDECKDEN
LOS LACADOS - OS LACADOS - I LACCATI

17-18/100

Les Coloris

	02012	Gris clématite		02081	Bordeaux pivoine		02075	Bleu campanule
	02016	Gris ombelle		02083	Rouge coquelicot		02073	Bleu bleuët
	02014	Gris jasmin		02082	Rouge capucine		02072	Bleu genêtine
	02011	Blanc lys		02051	Orange coulouma		02074	Bleu pervenche
	02024	Jaune réséda		02022	Jaune jonquille		02052	Mauve aster
	02015	Beige arum		02023	Jaune primevère		02065	Mauve amandine
	02013	Beige magnolia		02053	Pêche angélique		02071	Vert amandine
	02021	Beige dactyle		02092	Rose camélia		02064	Bleu myosotis
	02032	Brun roseaux		02091	Rose azalée		02066	Vert amarante
	02033	Brun noisetier		02090	Rose fuschia		02062	Vert lauriers
	02031	Brun pomme de pin		02050	Mauve iris		02061	Vert houx
	02041	Noir tulipe		02076	Bleu belle de nuit		02063	Vert gui
								Vert verveine

Les Acoustics®

	A10 + ref Ø 0,1 mm	Microperf
	A20 + ref Ø 0,15 mm	Acoperf
	A30 + ref Ø 0,2 mm	Microacoustic
	A40 + ref Ø 0,5 mm	Miniperf

Les Perforés®

	P10 + ref Ø 1 mm	Mediperf		P60 + ref Ø 4 mm	Maxiperf
	P20 + ref Ø 1 mm	Mezzoperf		P70 + ref Ø 4 mm	Megaperf
	P50 + ref Ø 2,8 mm	Solaperf		P80 + ref Ø 4,5 mm	Omégaperf



Arch. : Netanel Ben-Izchak



Arch. : Pietro Giordano



Arch. : Dalena Cermakova



Yves Durand, S.T.D.E 2A



Design : Mattia



Création : Angel Moretta



LES RÊVES SATINÉS® - THE SATINS - DIE SATINIERTEN LOS SATINADOS - OS ACETINADOS - I SATINATI

17-18/100



Les Coloris

	07083	Brique galapagos		07091	Rose marie galante		07071	Vert canaries
	07082	Orange bornéo		07093	Rose tahiti		07062	Vert açores
	07081	Orange sumatra		07094	Rose marquise		07061	Bleu palmyre
	07024	Orange ball		07092	Rose baléares		07021	Jaune ceylan
	07023	Orange java		07075	Bleu fidji		07011	Ivoire rhodes
	07022	Orange flores		07074	Bleu corfou		07010	Blanc wight
	07033	Beige bahamas		07073	Bleu midway		07015	Gris comores
	07019	Gris seychelles		07072	Bleu mayotte		07017	Gris livingstone
	07095	Rose hawaii		07064	Vert bermudes		07018	Gris célèbes
	07090	Rose désirade		07063	Vert antilles			



Les Acoustics®

	A10 + ref	Microperf
	Ø 0,1 mm	
	A20 + ref	Acoperf
	Ø 0,15 mm	
	A30 + ref	Microacoustic
	Ø 0,2 mm	



Les Perforés®

	P10 + ref	Mediperf
	Ø 1 mm	
	P20 + ref	Mezoperf
	Ø 1 mm	

	P50 + ref	Solaperf
	Ø 2,8 mm	
	P80 + ref	Omégaperf
	□ 4,5 mm	

Copyright, reproduction not permitted, 1990/2008, Normalu S.A. 68680 Kembs

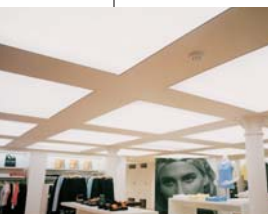

Design : Stephen Price - Bates



Design : Demeester & Berteloot



Arch. : ARCHICOM



Design : Demeester & Berteloot



Arch. : Marek Deyl & Jan Sestak



Design : Francis Billiet

LES INSPIRATIONS SATINÉES® - THE SATINS - DIE SATINIERTEN 17-18/100
LOS SATINADOS - OS ACETINADOS - I SATINATI 36/100*

Les Coloris

	D2012	Gris clématite		D2081	Bordeaux pivoine		D2075	Bleu campanule
	D2016	Gris ombelle		D2083	Rouge coquelicot		D2073	Bleu bleuets
	D2014	Gris jasmin		D2082	Rouge capucine		D2072	Bleu gentiane
	D2011	Blanc lys		D2051	Orange coulouma		D2074	Bleu pervenche
	D2024	Jaune réséda		D2022	Jaune jonquille		D2052	Mauve aster
	D2015	Beige arum		D2023	Jaune primevère		D2065	Vert amandine
	D2013	Beige magnolia		D2053	Pêche angélique		D2071	Bleu myosotis
	D2021	Beige dactyle		D2092	Rose camélia		D2064	Vert amarante
	D2032	Brun roseaux		D2091	Rose azalée		D2066	Vert lauriers
	D2033	Brun noisetier		D2090	Rose fuschia		D2062	Vert houx
	D2031	Brun pomme de pin		D2050	Mauve iris		D2061	Vert gui
	D2041	Noir tulipe		D2076	Bleu belle de nuit		D2063	Vert verveine

Les Acoustics®

	A10 + ref	Microperf
\varnothing 0,1 mm		
	A20 + ref	Acoperf
\varnothing 0,15 mm		
	A30 + ref	Microacoustic
\varnothing 0,2 mm		
	A40 + ref	Miniperf
\varnothing 0,5 mm		

* Les références P30, P40, P90 sont fabriquées exclusivement en 36/100.

* The references P30, P40, P90 are only available in thickness 36/100.

* Die Materialien P30, P40 und P90 sind nur in der Dicke 36/100 lieferbar.

Les Perforés®

	P10 + ref	Mediperf
\varnothing 1 mm		
	P20 + ref	Mezoperf
\varnothing 1 mm		
	P30 + ref	Lunaperf
\varnothing 1,5 mm		
	P40 + ref	Terraperf
\varnothing 2 mm		
	P50 + ref	Solaperf
\varnothing 2,8 mm		
	P60 + ref	Maxiperf
\varnothing 4 mm		
	P70 + ref	Megaperf
\varnothing 4 mm		
	P80 + ref	Omégaperf
\square 4,5 mm		
	P90 + ref	Gigaperf
\varnothing 10 mm		

* Las referencias P30, P40, P90 se fabrican únicamente con telas de 36/100.

* As referências P30, P40, P90 só podem ser fabricadas com a tela 36/100.

* I riferimenti P30, P40, P90 sono fabricati esclusivamente in 36/100.

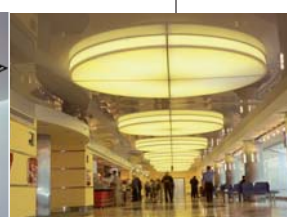



LES DAIMS AMBIANCE® - THE BRUSHED SUEDES - DIE BEFLOCKTEN DECKEN LOS ANTES - AS CAMURÇAS - I DAINI

29-30/100



Les Coloris

	05085	Bordeaux ambiance
	05083	Rouge passion
	05084	Rouille confort
	05086	Rose charme
	05115	Gris raffinement
	05088	Lilas cocooning
	05116	Gris intimité
	05071	Bleu ciel bien-être
	05073	Bleu marine nirvana
	05074	Bleu marine rêverie
	05041	Noir design

	05034	Brun décoration
	05032	Brun sérénité
	05055	Beige foncé évasion
	05024	Beige élégance
	05054	Or standing
	05154	Coquille douceur
	05114	Lin harmonie
	05056	Vert pastel détente
	05064	Vert style
	05062	Vert relaxation
	05021	Jaune douillet



Les Acoustics®

	A10 + ref	Microperf
$\varnothing 0,1 \text{ mm}$		
	A20 + ref	Acoperf
$\varnothing 0,15 \text{ mm}$		
	A30 + ref	Microacoustic
$\varnothing 0,2 \text{ mm}$		



Les Perforés®

	P10 + ref	Mediperf
$\varnothing 1 \text{ mm}$		
	P20 + ref	Mezzoperf
$\varnothing 1 \text{ mm}$		

	P50 + ref	solaperf
$\varnothing 2,8 \text{ mm}$		
	P80 + ref	Omégaperf
$\square 4,5 \text{ mm}$		

Copyright, reproduction not permitted, 1990/2008, Normalu S.A. 68680 Kembs

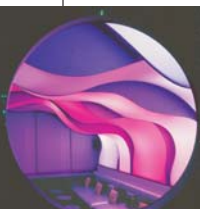

Arch. : Miguel Martins & BPC



Arch. : Lab Architecture Studio & Bates Smart



Arch. : Marek Deyl



Arch. : Massimiliano & Doriano Fuksas



Arch. : Mario Cucinella



Design : Lydia Fong Siew Ming and Team

LES MATS TRADITION® - THE MATTS - DIE MATTEN DECKEN
LOS MATES - OS MATES - GLI OPACHI

17-18/100

Les Coloris

	01016	Gris clair
	01010	Blanc
	01011	Ivoire
	01020	Beige
	01030	Brun foncé
	01040	Noir



ARCHITECTE : FEDERICO DIAZ

Les Acoustics®

	A10 + ref	Microperf
\varnothing 0,1 mm		
	A20 + ref	Acoperf
\varnothing 0,15 mm		
	A30 + ref	Microacoustic
\varnothing 0,2 mm		
	A40 + ref	Miniperf
\varnothing 0,5 mm		

Les Perforés®

	P10 + ref	Mediperf
\varnothing 1 mm		
	P20 + ref	Mezzoperf
\varnothing 1 mm		
	P50 + ref	Solaperf
\varnothing 2,8 mm		

	P60 + ref	Maxiperf
\varnothing 4 mm		
	P70 + ref	Megaperf
\varnothing 4 mm		
	P80 + ref	Omégaperf
\square 4,5 mm		



Arch. : Murat Denizati

Arch. : Gilles Morais

Arch. : ECO* ID

URS Corporation

Arch. : Tim Power

Studio Baalocchi



LES TRANSLUCIDES® - THE TRANSLUCENTS - DIE TRANSLUZIDEN LOS TRANSLUCIDOS - AS TRANSLUCIDAS - I TRASLUCIDI

17-30/100



Les Coloris

	04072	Planète bleue
	04011	Blanc vénéus
	04013	Clair de lune
	04015	Mercurie
	04073	Neptune
	04016	Sedna
	04010	Néréide



Les Acoustics®

	A10 + ref	Microperf
	Ø 0,1 mm	
	A20 + ref	Acoperf
	Ø 0,15 mm	
	A30 + ref	Microacoustic
	Ø 0,2 mm	
	A40 + ref	Miniperf
	Ø 0,5 mm	



Les Perforés®

	P10 + ref	Mediperf
	Ø 1 mm	
	P40 + ref	Terraperf
	Ø 2 mm	
	P50 + ref	Solaperf
	Ø 2,8 mm	
	P80 + ref	Omégaperf
	□ 4,5 mm	

LES MÉTALS® - THE METALLICS - DIE METALLDECKEN LOS METALICOS - OS METAIS - I METALLICI

17-18/100



Les Coloris

	06023	Argenté
	06010	Fleur de métal
	06070	Vert métal
	06020	Laiton
	06022	Doré
	06021	Bronze
	06090	Rose métal



Les Acoustics®

	A10 + ref	Microperf
	Ø 0,1 mm	
	A20 + ref	Acoperf
	Ø 0,15 mm	
	A30 + ref	Microacoustic
	Ø 0,2 mm	
	A40 + ref	Miniperf
	Ø 0,5 mm	
	P10 + ref	Mediperf
	Ø 1 mm	



Les Perforés®

	P20 + ref	Mezzoperf
	Ø 1 mm	
	P50 + ref	Solaperf
	Ø 2,8 mm	
	P60 + ref	Maxiperf
	Ø 4 mm	
	P70 + ref	Megaperf
	Ø 4 mm	
	P80 + ref	Omégaperf
	□ 4,5 mm	

Copyright, reproduction not permitted, 1990/2008, Normalu S.A. 68680 Kembs



Arch. : ECO® ID



Arch. : H. Penaranda & Y. Valesco



Arch. : Federico Diaz



Arch. : Firoka



Arch. : Micro de la TSR







Arch. : Karim Azzabi

LES XTREMES® - THE X-WIDE - DIE X-TREM
LAS GRANDES - AS GRANDES - X-LARGE

17-30/100

Les Coloris

	X1010	Blanc mat
	X4015	Mercre translucide
	X4016	Sedna translucide
	X7010	Blanc wight satiné

Les Perforés®

	P20 + ref	Mezzoperf
	Ø 1 mm	



DESIGN : C.S. LYON PRAHA DESIGN

Les couleurs imprimées peuvent présenter un léger écart avec la réalité, notre carte d'échantillons est à votre disposition pour plus de précisions. Les reflets dans le laqué peuvent varier en fonction des formes, séparations et autres. La largeur des lés sans soudure varie de 1m50 à 2m56 selon le type de finition. Merci de consulter le tableau de largeur des lés pour connaître les dimensions exactes. En fonction de l'intensité de l'exposition au rayonnement solaire, de la composition de l'atmosphère (fumée...) de la pièce, la teinte peut légèrement varier dans le temps.

Printed colors may present a slight variation with the reality, our sample booklet is available for more precision. The reflections in the lacquer finish may vary depending on the shapes, separations and others. The width of the sheet without weld can vary from 150 cm to 256 cm depending on the finition. Thanks to check the width table to get the exact dimensions. Depending on the intensity of the solar radiance exposition and the atmosphère composition (smoke..) of the room, the shade of the sheet may vary in the time.

Die gedruckten Farben können in der Realität von der Darstellung abweichen; eine Broschüre mit Muster ist für genauere Abgleiche erhältlich. Der Spiegeleffekt der Lackfolien kann je nach Form, Aufteilung und weiteren Faktoren variieren. Die Folienbreite ohne Schweißnaht variiert je nach Folientyp zwischen 150 cm und 256 cm. Bitte überprüfen Sie die genauen Abmessungen in der Tabelle mit den Breitenangaben. Abhängig von der Sonneneinstrahlung und der Luftzusammensetzung im Raum (Rauch ...) kann sich das Erscheinungsbild der Folien zeitlich ändern.

I colori stampati possono presentare un leggero scarto con la realtà, la nostra carta di campioni è vostra disposizione per più precisazioni. La gamma dei laccati puo variare in funzione delle forme, separazioni e altro. La larghezza del telo senza saldatura varia da 1m50 a 2m56 secondo il tipo di finitura. La prego di consultare la tabella di larghezza dei teli per conoscere le dimensioni esate. In funzione dell'intensità dell'esposizione ai raggi del sole e della composizione dell'atmosfera (fumo..) della stanza, la tinta del telo puo leggermente variare col tempo.

Dado que estos colores fueron impresos puede existir una diferencia con la realidad, por eso nuestra carta con muestras está a su disposición para una mayor precisión. Los reflejos de las telas lacadas pueden variar en función de las formas, separaciones y otros. La anchura de telas sin soldadura puede variar entre 1m50 y 2m56 según el acabado elegido. Gracias por consultar el listado de anchuras de las telas para medidas exactas. Según la intensidad de la exposición a la radiación solar, de la composición de la atmósfera de la habitación (humo...), el tinte puede variar con el tiempo.

Visto que as cores foram imprimidas pode haver diferenças com a realidade, por isso a nossa carta de cores com amostras de tela está ao seu dispor. Os reflexos das telas lacadas podem variar em função das formas, separações e outros. A largura des telas sem soldadura pode variar entre 1m50 até 2m56 segundo a acado de tela escolhido. É favor consultar a tabela das larguras de tela para conhecer as medidas exactas. Segundo a intensidade de exposição ao brilho solar, da composição da atmosfera (fumo...) da peça, a côr pode variar com o passar do tempo.



Arch. : David Betts & Paolo Dario



Arch. : Muma Company



Arch. : Bredt & Partner



Arch. : The Syntax Group UK



Arch. : Kingsmen Projects Pte LTD



Arch. : Zebra



LES RECYCLÉS® - THE RECYCLED - DIE ÖKOLOGISCHEN LAS RECICLADAS - AS RECICLADAS - I RICICLABILI

17-18/100

C'est depuis longtemps que Barrisol accorde une grande importance au respect de l'environnement.

Les toiles Barrisol sont recyclables à 100%. De plus, l'ensemble des matériaux utilisés pour la production est recyclable ou fait de matières recyclées (emballages, conditionnements...).

La nouvelle gamme de toiles «Les recyclés» va encore plus loin puisqu'en plus d'être recyclables à 100% comme toutes les autres toiles Barrisol, elles sont fabriquées à partir de matières Barrisol recyclées.

Since the beginning Barrisol is claiming his ecological commitment by respecting the environment.

Barrisol sheets are 100% recyclable. Furthermore, the raw material used for production are recyclable or made with recycled materials (packaging, shipping packing...)

On top of these recyclable sheets Barrisol get further by offering a product range named «The recycled» in which all the sheets are done with Barrisol recycled matters.

Wir messen dem Umweltschutz schon seit langer Zeit eine große Bedeutung bei.

Daher verwenden wir für die Herstellung der BARRISOL-Spanndecken ausschließlich Materialien, die entweder wiederverwertbar sind oder bereits wieder verwertet werden.

BARRISOL bietet nun eine neue Serie von Spannfolien an: die Ökologischen - les Recyclés. Diese Folien werden ausschließlich aus wiederverwerteten Barrisol Materialien hergestellt.

Da sempre Barrisol s'impegna nell'ambito dell'ecologia contribuendo al rispetto dell'ambiente. I teli Barrisol sono riciclabili al 100%. In più, l'insieme dei materiali utilizzati per la produzione è riciclabile o



Les Coloris

	R01	Beige
	R02	Blanc
	R03	Gris
	R04	Noir



Les Acoustics®

	A10 + ref	Microperf	Ø 0,1 mm
	A20 + ref	Acoperf	Ø 0,15 mm
	A30 + ref	Microacoustic	Ø 0,2 mm
	A40 + ref	Miniperf	Ø 0,5 mm



Les Perforés®

	P10 + ref	Mediperf	Ø 1 mm
	P20 + ref	Mezoperf	Ø 1 mm
	P50 + ref	Solaperf	Ø 2,8 mm
	P60 + ref	Maxiperf	Ø 4 mm
	P70 + ref	Megaperf	Ø 4 mm
	P80 + ref	Omégaperf	□ 4,5 mm

Desde siempre Barrisol asume su conciencia ecológica y contribuye al respecto del medio ambiente. Las telas Barrisol son reciclables al 100%; todos los materiales usados en producción son reciclables o hechos de materias recicladas (embalajes, acondicionamiento, ...). Además de producir telas reciclables, Barrisol empeña su responsabilidad ecológica lanzando una nueva gama de telas "recicladas" compuesta de materia Barrisol reciclada.

Desde sempre Barrisol afirma o seu compromisso ecológico contribuindo para o respeito do meio-ambiente. As telas Barrisol são recicláveis à 100%. Além disso, o conjunto dos materiais utilizados para a produção são também reciclados ou feito de matérias reciclados (embalagens, acondicionamentos...).

Além de produzir as telas recicláveis, Barrisol compromete-se mais propondo a sua nova gama «As telas recicladas» cujas telas são fabricadas a partir de materiais Barrisol reciclados.

composto da materie riciclabili (imballaggio, condizionamento...)

Oltre a produrre dei teli riciclabili, Barrisol s'impegna ancora proponendo una nuova gamma «Les recyclés» i cui teli sono fabricati di materiale Barrisol riciclabile.

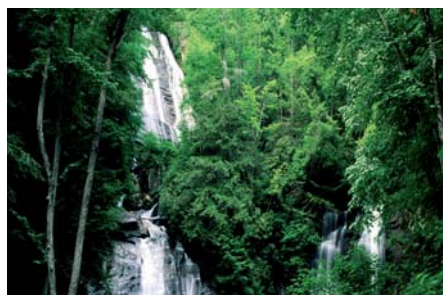

Copyright, reproduction not permitted. 1990/2008, Normalu S.A. 68680 Kembs



Design : TIMBETTEX



Design : Alain Dumont



Architecte Cadco AB Sweden



Arch. : Dennis Lau & Ng Chun Man



Architecte Michel JAUSSAUD



Arch. : Maciej Miller

TECHNICAL SPECIFICATIONS FOR BARRISOL FABRICS

Specially designed to meet Barrisol universe ceiling and wall requirements.

Definition:

- high-performance flexible panel, flame-retarded throughout
- guaranteed cadmium-free polyvinyl chloride-based copolymer

Reaction with fire: - naturally non-flammable, M1 classification

Resistance:

- resists: water and damp, seawater, copper salt solutions, X-rays.
- resists at a maximum concentration of 15%: sulphuric acid, nitric acid
- resists at a maximum concentration of 10%: soda lye

Hygiene: - non-toxic, naturally fungicidal, sterilisable, washable

Dimensions – weight:

Fabric texture	Panel thickness	Weight
Matt – lacquered – satin – metallic – perforated - translucent	≈ 18/100 mm	≈ 180 g/sqm ≈ 18 g/sqft
Brushed suede - perforated	≈ 36/100 mm	≈ 320 g/sqm ≈ 32 g/sqft

- dimensional stability: -15°C to +45°C

Hygrometry: Permeability to water vapour

for hygrometric degree < 65% RH = 0.0030 g/hr sqm mm Hg
 for hygrometric degree > 65% RH = 0.0045 g/hr sqm mm Hg

In view of the results of these measurements, the fabric may be considered to be a very effective impermeable barrier to water

Heat conductivity coefficient: 0.16 x cal/m H°C

Heat coefficient K with 3 cm air gap + 4.5 cm glass wool insulating materials: K = 0.785

Mechanical characteristics:

Strength	Longitudinal	Transversal
Tear strength	196.50 kg/sqcm or 2788.34 lb/in ²	220.80 kg/sqcm or 3133.15 lb/in ²
Elongation at rupture	231 %	309 %
Tensile strength and elongation at rupture (ISO weight standard)	S = 1,60 dN E = 170 %	S = 2,00 dN E = 255 %

Reflexion and light transmission characteristics of the sheet

Fabrics	% reflection	% transmission
02011 Blanc lys laqué	≈ 78,8	≈ 9,6
01010 Blanc mat	≈ 81	≈ 9,8
02073 Bleu bleuet laqué	≈ 10	≈ 0,1
04013 Translucide clair de lune	≈ 43,8	≈ 72

Material retention: Shape-retentive molecules

Fabric recycling: 100% recyclable, respecting the environment



EXAMPLES OF PROJECTS



Architects: Marek Deyl, Jan Sestak



Creation André Dillmann



AXE Architecture



Architect: Hakan Kiran



Produced by Collin



Kay Elliott Architects



Design: Demeester & Berteloot



*Architects: Belaen + Van De Loock
Design: Francis Billiet*



Architect: Arrowstreet



Design: Francis Billiet



Blaser + Morath, Mr Frigerio



Architect: Hakan Kiran

PATENTED TRACKS AND RAILS
(ALL MEASUREMENTS ARE IN MILLIMETERS)

BARRISOL CLASSIC TRACKS AND RAILS

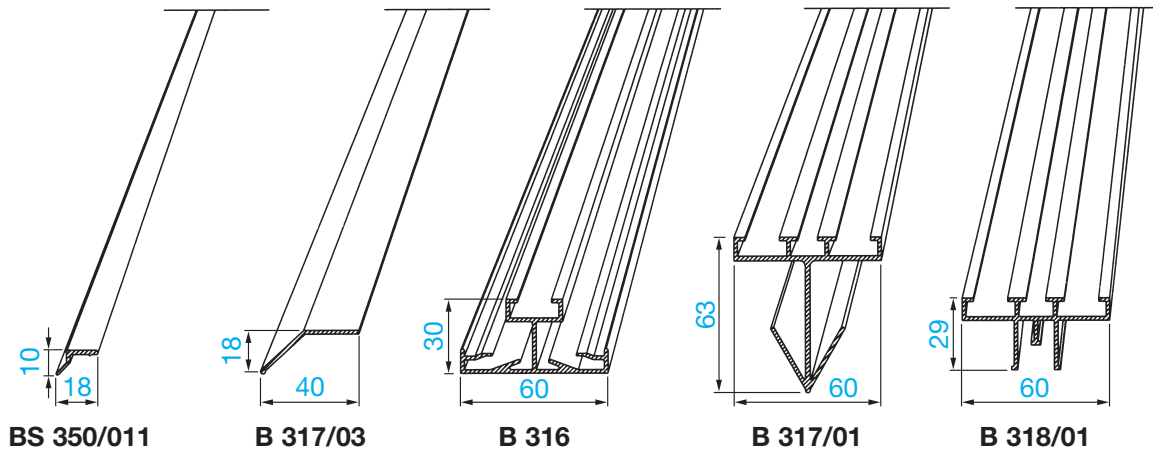
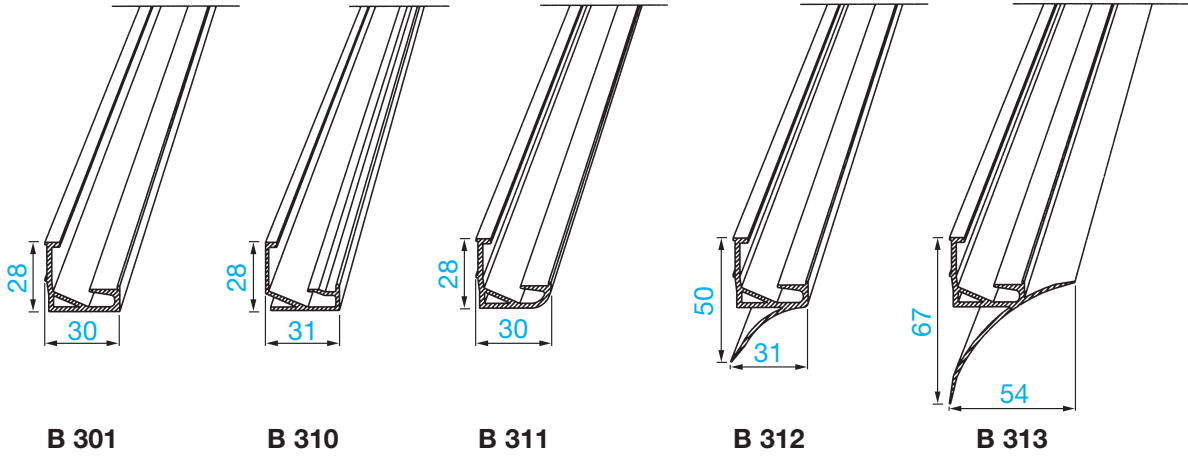

BARRISOL STAR TRACKS AND RAILS

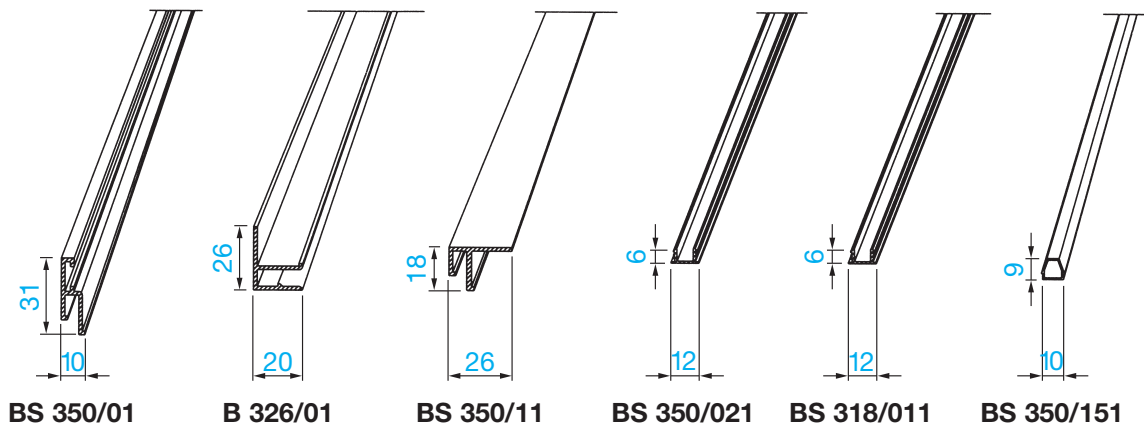

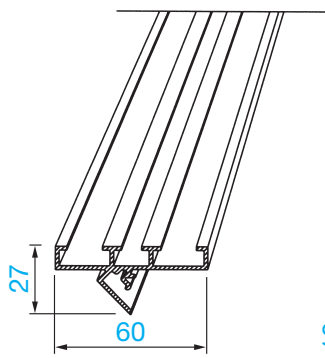

BS 350/201

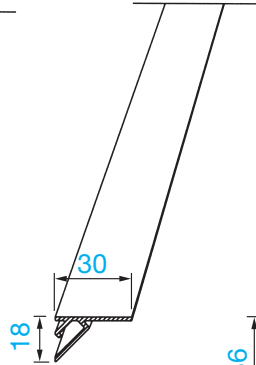

BS 350/202

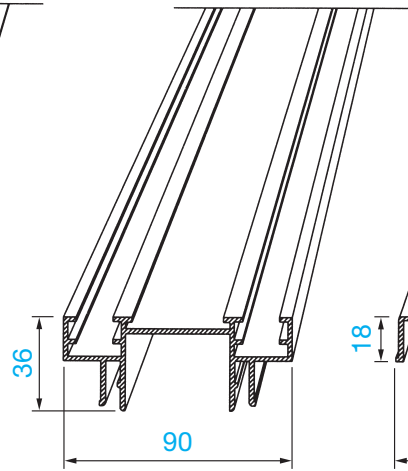

BS 350/19

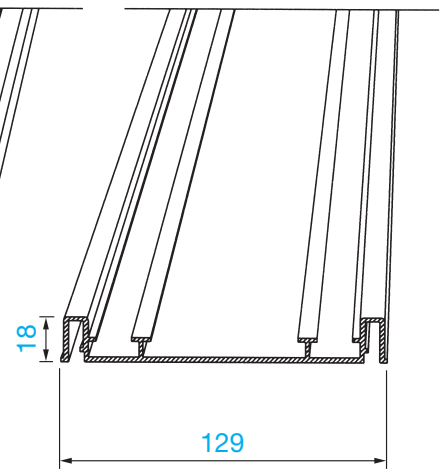

BS 350/18

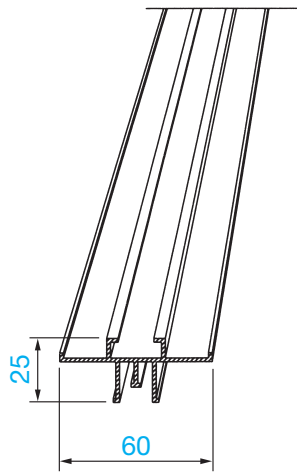

BS 350/02

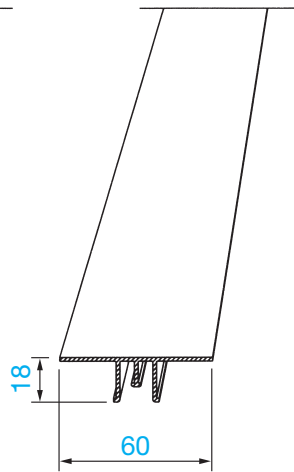

BS 350/16

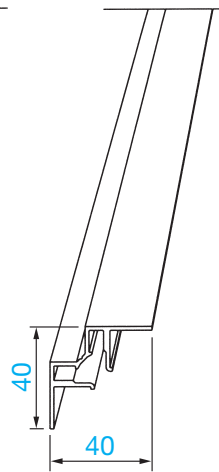

BS 350/15

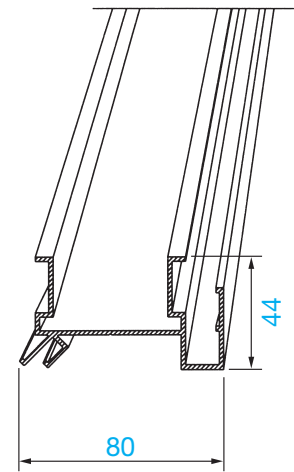

BS 355/01

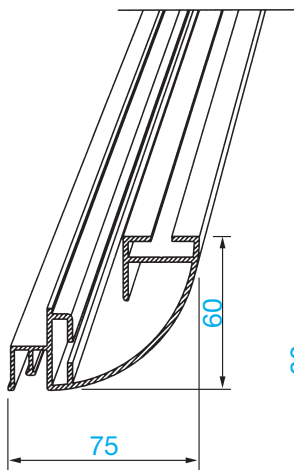

BS 350/165

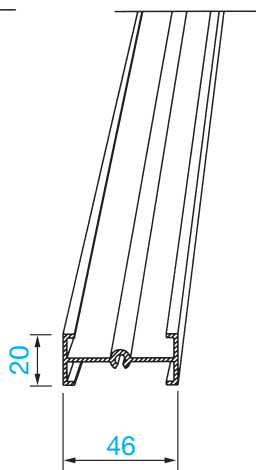

BS 355/03

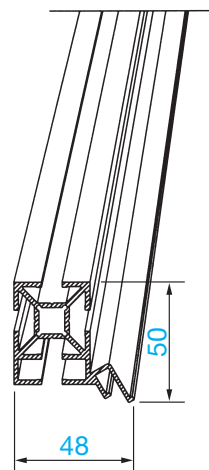

BS 355/04

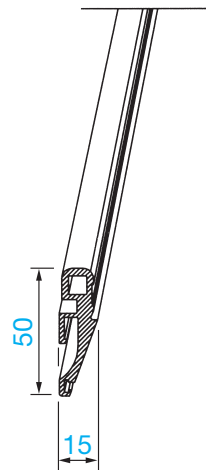

BS 355/05

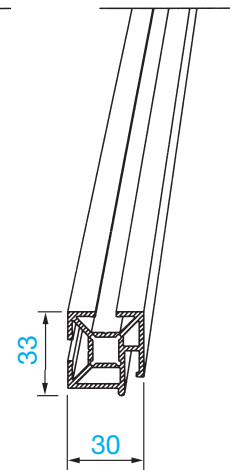

BS 355/06

BARRISOL CLASSIC AND BARRISOL STAR

WHY USE THEM?

IN NEW BUILDINGS OR FOR REFURBISHING PURPOSES, BARRISOL OFFERS AN EXCELLENT SOLUTION FOR TECHNICAL PROBLEMS AND A REMARKABLY AESTHETIC RESULT.

CUSTOM-MADE, BARRISOL CAN BE ADAPTED TO ANY SURFACE, ANY SHAPE, ANY SITUATION, ANY PLACE.

IN ADDITION, BARRISOL WHEN INCORPORATED INTO THE ARCHITECTURE, MEETS THE WELL-BEING NEEDS EXPECTED FROM ADVANCED TECHNOLOGICAL MATERIALS AND OFFER QUALITIES FOR EACH CRITERIA FOR USE.

COMFORT



- Improve the thermal and acoustic comfort of buildings.
- Aesthetic comfort: clean, beautiful ceilings.
- Pleasant rooms, new sense of well-being.
- The lacquered version gives an impression of space and luminosity.

DECOR



- Can be incorporated into or combined with decors, enhancing them.
- Can be adapted to any style, any living space through the range of textures and colours.
- 95 colours available for plain textures, 5 perforated variations.
- Lacquered version reflects decors.
- Multi-colours are available in any shape or size.
- Painted or printed wall and ceiling decors.

DESIGN



- Creative scope.
- Wide variety of possible designs with Barrisol Classic
- Infinite design possibilities with Barrisol Star.
- Can be adapted to any surface, shape, situation or place.
- Allow all types of shapes: horizontal, rounded, angled, 3D.
- Completely new designs produced.

LIGHTING



- Benefit from Barrisol techniques to incorporate all types of lighting.
- Incorporate suspended or built-in lighting, spots, optical fibres.
- On large surfaces, lighting strips act as separators.
- Light separators or rails can be incorporated into Barrisol Star separators.
- Translucent ceilings and walls diffuse light.
- Lacquered fabrics propagate light through reflection.



ENVIRONMENT

- Protect the environment – low energy consumption.
- ≈ 1000 m² - sqft 10,000 sqft of Barrisol represents < 180 kg- 360 lb of material for a ≈ 0,10 m³ - 3,53 sq³ volume. (A wooden ceiling of the same size represents ≈ 50 m³ - 1765 sq³ of planted wood).
- Long service life.
- 100% recyclable.

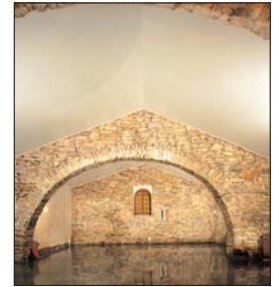

SAVINGS

- Guaranteed by the manufacturer for 10 years against manufacturing defects: harpoon and strip seams.
- Excellent value for money, durable installation.
- Easy to maintain.
- Protects frames, concrete or steel structures, roofing soffits.
- Offer dual energy savings: decrease in volume to be heated, reduction in heat losses.

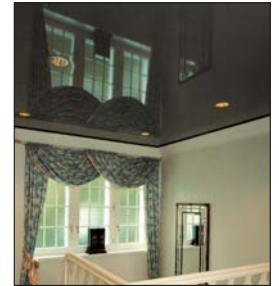

MAINTENANCE

- Ceiling can be disassembled at any time in a matter of minutes.
- Easy access to plenum in the event of water damage, repair work on technical equipment, and return to original shape.
- Can be cleaned with suitable Barrisol products (except brushed suede).
- New light systems and technical equipment can always be installed in conjunction by the Barrisol approved installation specialist.

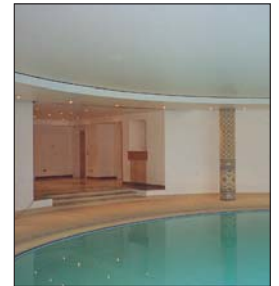

AESTHETICS

- Superb, exceptional finish.
- Enhance new or refurbished buildings.
- Provide an aesthetic solution for all technical problems.
- Pure lines and shapes contribute to the aesthetic result.
- The choice of colours allows attractive designs.
- Offer all the assets required to give a sense of beauty and harmony.



WATERPROOF

- Insensitive to damp, condensation, effective vapour barrier.
- Suitable for buildings with high relative humidity levels.
- Most textures are washable with water.
- Impermeable to water. They have often protected rooms in the event of water damage by forming a retention pouch in the event of water infiltration and returning to their initial shape after draining.

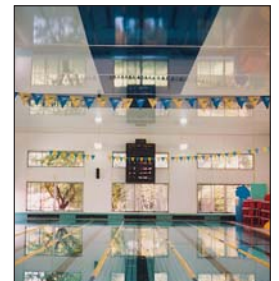

HYGIENE

- Several textures washable with suitable products.
- Washable with water hose in some cases.
- Retain dust from plenum. Prevent ceiling fibres from being suspended in air.
- Guaranteed free of cadmium and solvent releases.
- Fungicidal, with no mould growth.
- Non-toxic (in compliance with European and international standards).





INNOVATIVE

- Benefit from continuous technical and decorative progress
- Extend their applications to new sectors, create suitable techniques.
- Allow innovative designs, increasing creative scope.
- Can be used for any new project.



INSTALLATION

- Installed by Barrisol approved professionals.
- Tracks are secured at the desired height on the wall perimeter.
- The ceilings, custom-made in the factory, are stretched when hot and inserted into the tracks.
- Quick installations, producing no debris, reducing room immobilisation time.
- Dry and clean installation



SOUNDPROOFING

- Create a softer atmosphere due to the air lock in the plenum.
- Barrisol Acoustic can be combined with insulating materials for good room acoustic correction.
- High-performance acoustic correction tests in school buildings.
- Finer musical effect.
- Optimal office soundproofing.



HEAT INSULATION

- With the hollow ceiling or high floor, Barrisol creates an air lock.
- The air lock, similar to double glazing, forms an insulating buffer and prevents condensation formation on the Barrisol fabric.
- Reduces heat loss from attic floors.
- Decreases volumes to be heated through easy installation at the desired height.
- Can be combined with heat insulation for excellent results.



DURABILITY

- Barrisol durability is certified by satisfied customers for the last 30 years.
- No loss of technical characteristics over time.
- Stay constantly stretched.
- Retain shapes.
- Keeps the beautiful lines under normal conditions of use.



RETENTION

- Composed of retentive molecules.
- After distortion, return to the initial shape and tension.
- Returns to the initial shape after each reassembly.
- Absorb ball impacts and retrieve their tension.
- Will retrieve their position after removal of debris from the plenum.
- Will retrieve the tension after water damage is drained.



REFURBISHING

- Allow new creations when refurbishing, elegant compositions, aesthetic results.
- Quick installation, furniture does not need to be moved.
- Offer solutions for faulty ceiling problems using suitable techniques.
- Can be installed under faulty ceilings, retaining detachable fibres.
- Can be fitted in attics, refurbish damp rooms.

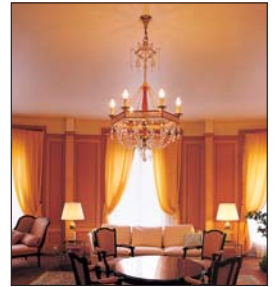

RESISTANCE

- Cold and heat-resistant.
- Tension is maintained constantly.
- Resist seawater, chlorine, most gaseous vapours such as formol, ether, trichlorethylene, etc.
- Insensitive to X-rays.
- Withstand significant loads caused by water damage.



SAFETY

- Firebreak ceilings (in complex), incorporate all safety devices.
- Meet safety requirements – M1 classification in France and other classifications abroad.
- Subject to approvals from the Ministry of the Interior in France and safety and hygiene organisations in France and many other countries.
- Due to their low weight, they do not cause injury in the event of explosions or earthquakes.
- No static electricity accumulation in the plenum.



STABILITY

- Techniques devised for installation stability.
- Special techniques for large surfaces.
- Techniques for sloping ceiling stability
- Very high ceiling stability.
- Stability of equipment installed in ceilings.
- Thermally stable from -40 to +50°C, no visible change in appearance.

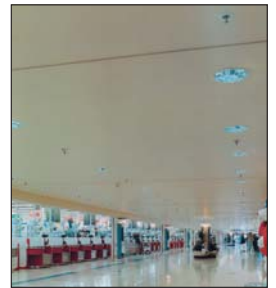

TECHNICAL ASPECTS

- Provide a suitable solution for each technical problem.
- Compensate for design defects and visible malformations in slabs.
- Prevent cutting apertures, since electric cables can be placed in the plenum.
- Do not overload frames.
- Prevent thermal bridges.



VOLUMES

- Lacquered versions increase volumes visually.
- The Barrisol Star 3D challenge: Barrisol Star 3D is stretched and sculptured in 3 dimensions.
- Barrisol Star refurbishes 3 ceilings in 3 dimensions, respecting the architecture.
- Barrisol Creaform creates volumes in Barrisol Star 3D on aluminium structures.
- Barrisol Creaform can be incorporated into Barrisol Star ceilings.
- Create a wide range of infinitely original decors.



**BARRISOL
CLASSIC
BARRISOL
STAR**

**ADVANTAGES FOR
EACH LOCATION**

	AIRPORTS	FOOD INDUSTRY	APARTMENTS	AMPHITHEATRES	BANKS	MARINE	OFFICES	CANTEENS	CASINOS, CINEMAS	LEISURE CENTRES	MEDICAL CENTRES	SPORTS CENTRES	SHOPS	CAR DEALERSHIPS	INFANT SCHOOLS
1 Soundproofing	◆	◆	◆	◆	◆	◆	◆	◆	◆	◆	◆	◆	◆	◆	◆
2 Approved for use with food		◆						◆							
3 Projected asbestos: (confinement)*	◆	◆	◆	◆	◆	◆	◆	◆	◆	◆	◆	◆	◆	◆	◆
4 Non-reflecting (brushed suede, matt, satin)					◆										
5 Reinforced anti-static / Ref. 08S211		◆									◆				
6 Built-in technical equipment possible	◆	◆	◆	◆	◆	◆	◆	◆	◆	◆	◆	◆	◆	◆	◆
7 Hides existing ceiling defects	◆	◆	◆	◆	◆	◆	◆	◆	◆	◆	◆	◆	◆	◆	◆
8 Radiating heating through ceiling	◆	◆	◆	◆	◆	◆	◆	◆	◆	◆	◆	◆	◆	◆	◆
9 Condensation eliminated	◆	◆	◆	◆	◆	◆	◆	◆	◆	◆	◆	◆	◆	◆	◆
10 Complies with applicable regulations	◆	◆	◆	◆	◆	◆	◆	◆	◆	◆	◆	◆	◆	◆	◆
11 Decontamination possible (except brushed suede)											◆				
12 Disassembly and reassembly possible	◆	◆	◆	◆	◆	◆	◆	◆	◆	◆	◆	◆	◆	◆	◆
13 Smoke clearance	◆	◆		◆	◆	◆			◆	◆		◆	◆	◆	◆
14 Energy savings	◆	◆	◆	◆	◆	◆	◆	◆	◆	◆	◆	◆	◆	◆	◆
15 Elasticity	◆	◆	◆	◆	◆	◆	◆	◆	◆	◆	◆	◆	◆	◆	◆
16 Waterproof, impermeable	◆	◆	◆	◆	◆	◆	◆	◆	◆	◆	◆	◆	◆	◆	◆
17 Guaranteed 10 years	◆	◆	◆	◆	◆	◆	◆	◆	◆	◆	◆	◆	◆	◆	◆
18 Guaranteed crack and spectrum-free	◆	◆	◆	◆	◆	◆	◆	◆	◆	◆	◆	◆	◆	◆	◆
19 Damp: insensitive	◆	◆	◆	◆	◆	◆	◆	◆	◆	◆	◆	◆	◆	◆	◆
20 Hygiene	◆	◆	◆	◆	◆	◆	◆	◆	◆	◆	◆	◆	◆	◆	◆
21 Absorbs impacts from balls										◆		◆			
22 Non-flammable	◆	◆	◆	◆	◆	◆	◆	◆	◆	◆	◆	◆	◆	◆	◆
23 Acoustic insulation possible	◆	◆	◆	◆	◆	◆	◆	◆	◆	◆	◆	◆	◆	◆	◆
24 Sound insulation possible	◆	◆	◆	◆	◆	◆	◆	◆	◆	◆	◆	◆	◆	◆	◆
25 Washable in matt – satin – lacquered	◆	◆	◆	◆	◆	◆	◆	◆	◆	◆	◆	◆	◆	◆	◆
26 Dust barrier	◆	◆	◆	◆	◆	◆	◆	◆	◆	◆	◆	◆	◆	◆	◆
27 Light weight, safe	◆	◆	◆	◆	◆	◆	◆	◆	◆	◆	◆	◆	◆	◆	◆
28 Installation possible without interrupting activity	◆	◆	◆	◆	◆	◆	◆	◆	◆	◆	◆	◆	◆	◆	◆
29 Quick, clean, well-finished installation	◆	◆	◆	◆	◆	◆	◆	◆	◆	◆	◆	◆	◆	◆	◆
30 Improved sales environments presentation		◆			◆				◆				◆	◆	
31 Cleanliness	◆	◆	◆	◆	◆	◆	◆	◆	◆	◆	◆	◆	◆	◆	◆
32 X-rays (insensitive)											◆				
33 Thermal stability	◆	◆	◆	◆	◆	◆	◆	◆	◆	◆	◆	◆	◆	◆	◆
34 Stable over time	◆	◆	◆	◆	◆	◆	◆	◆	◆	◆	◆	◆	◆	◆	◆
35 Room surveillance by means of lacquer effect													◆		
36 Variety of shapes, colours	◆	◆	◆	◆	◆	◆	◆	◆	◆	◆	◆	◆	◆	◆	◆
37 Reduced volumes to be heated	◆	◆	◆	◆	◆	◆	◆	◆	◆	◆	◆	◆	◆	◆	◆

* According to current legislation



	PRIMARY AND SECONDARY SCHOOLS	ELECTRICITY, RAILWAYS, POST OFFICES	LARGE SURFACES	SOCIAL HOUSING	HOSPITALS	HOTELS-RESTAURANTS	INDUSTRY	COMPUTER ROOMS	LABORATORIES	PLACES OF WORSHIP	MUNICIPAL BUILDINGS	PRIVATE RESIDENCES	MUSEUMS	SWIMMING POOLS	PHARMACEUTICAL PRODUCTION	REFURBISHING	MUSIC ROOMS	PHOTOGRAPHY ROOMS	COMMUNITY HALLS	SPORTS HALLS	CONFERENCE ROOMS	HAIRDRESSING SALONS	THALASSOTHERAPY	UNIVERSITIES
1	◆	◆	◆	◆	◆	◆	◆	◆	◆	◆	◆	◆	◆	◆	◆	◆	◆	◆	◆	◆	◆	◆	◆	◆
2			◆																					
3	◆	◆	◆	◆	◆	◆	◆	◆	◆	◆	◆	◆	◆	◆	◆	◆	◆	◆	◆	◆	◆	◆	◆	◆
4									◆									◆						
5					◆			◆	◆						◆									
6	◆	◆	◆	◆	◆	◆	◆	◆	◆	◆	◆	◆	◆	◆	◆	◆	◆	◆	◆	◆	◆	◆	◆	◆
7	◆	◆	◆	◆	◆	◆	◆	◆	◆	◆	◆	◆	◆	◆	◆	◆	◆	◆	◆	◆	◆	◆	◆	◆
8	◆	◆	◆	◆	◆	◆	◆	◆	◆	◆	◆	◆	◆	◆	◆	◆	◆	◆	◆	◆	◆	◆	◆	◆
9	◆	◆	◆	◆	◆	◆	◆	◆	◆	◆	◆	◆	◆	◆	◆	◆	◆	◆	◆	◆	◆	◆	◆	◆
10	◆	◆	◆	◆	◆	◆	◆	◆	◆	◆	◆	◆	◆	◆	◆	◆	◆	◆	◆	◆	◆	◆	◆	◆
11					◆																			
12	◆	◆	◆	◆	◆	◆	◆	◆	◆	◆	◆	◆	◆	◆	◆	◆	◆	◆	◆	◆	◆	◆	◆	◆
13	◆		◆		◆	◆	◆		◆		◆		◆		◆		◆	◆		◆		◆	◆	◆
14	◆	◆	◆	◆	◆	◆	◆	◆	◆	◆	◆	◆	◆	◆	◆	◆	◆	◆	◆	◆	◆	◆	◆	◆
15	◆	◆	◆	◆	◆	◆	◆	◆	◆	◆	◆	◆	◆	◆	◆	◆	◆	◆	◆	◆	◆	◆	◆	◆
16	◆	◆	◆	◆	◆	◆	◆	◆	◆	◆	◆	◆	◆	◆	◆	◆	◆	◆	◆	◆	◆	◆	◆	◆
17	◆	◆	◆	◆	◆	◆	◆	◆	◆	◆	◆	◆	◆	◆	◆	◆	◆	◆	◆	◆	◆	◆	◆	◆
18	◆	◆	◆	◆	◆	◆	◆	◆	◆	◆	◆	◆	◆	◆	◆	◆	◆	◆	◆	◆	◆	◆	◆	◆
19	◆	◆	◆	◆	◆	◆	◆	◆	◆	◆	◆	◆	◆	◆	◆	◆	◆	◆	◆	◆	◆	◆	◆	◆
20	◆	◆	◆	◆	◆	◆	◆	◆	◆	◆	◆	◆	◆	◆	◆	◆	◆	◆	◆	◆	◆	◆	◆	◆
21																								
22	◆	◆	◆	◆	◆	◆	◆	◆	◆	◆	◆	◆	◆	◆	◆	◆	◆	◆	◆	◆	◆	◆	◆	◆
23	◆	◆	◆	◆	◆	◆	◆	◆	◆	◆	◆	◆	◆	◆	◆	◆	◆	◆	◆	◆	◆	◆	◆	◆
24	◆	◆	◆	◆	◆	◆	◆	◆	◆	◆	◆	◆	◆	◆	◆	◆	◆	◆	◆	◆	◆	◆	◆	◆
25	◆	◆	◆	◆	◆	◆	◆	◆	◆	◆	◆	◆	◆	◆	◆	◆	◆	◆	◆	◆	◆	◆	◆	◆
26	◆	◆	◆	◆	◆	◆	◆	◆	◆	◆	◆	◆	◆	◆	◆	◆	◆	◆	◆	◆	◆	◆	◆	◆
27	◆	◆	◆	◆	◆	◆	◆	◆	◆	◆	◆	◆	◆	◆	◆	◆	◆	◆	◆	◆	◆	◆	◆	◆
28	◆	◆	◆	◆	◆	◆	◆	◆	◆	◆	◆	◆	◆	◆	◆	◆	◆	◆	◆	◆	◆	◆	◆	◆
29	◆	◆	◆	◆	◆	◆	◆	◆	◆	◆	◆	◆	◆	◆	◆	◆	◆	◆	◆	◆	◆	◆	◆	◆
30																								
31	◆	◆	◆	◆	◆	◆	◆	◆	◆	◆	◆	◆	◆	◆	◆	◆	◆	◆	◆	◆	◆	◆	◆	◆
32					◆				◆															
33	◆	◆	◆	◆	◆	◆	◆	◆	◆	◆	◆	◆	◆	◆	◆	◆	◆	◆	◆	◆	◆	◆	◆	◆
34	◆	◆	◆	◆	◆	◆	◆	◆	◆	◆	◆	◆	◆	◆	◆	◆	◆	◆	◆	◆	◆	◆	◆	◆
35																								
36	◆	◆	◆	◆	◆	◆	◆	◆	◆	◆	◆	◆	◆	◆	◆	◆	◆	◆	◆	◆	◆	◆	◆	◆
37	◆	◆	◆	◆	◆	◆	◆	◆	◆	◆	◆	◆	◆	◆	◆	◆	◆	◆	◆	◆	◆	◆	◆	◆

GENERAL INSTALLATION CONDITIONS

FOR BARRISOL STRETCH CEILINGS

In buildings under construction, ceilings can be installed only in buildings protected from air, water and dust.

The plenum should be 100% airtight.

The insulating materials fitted in the plenum should have a minimum fire classification of M1 (non-flammable).

Rolling shutter boxes must be airtight.

The ceilings are custom-made in the factory, adaptations and finishing work can be achieved during installation.

Spot transformers are generally attached directly to the existing ceiling or on walls. The Barrispot is designed to house the transformer which can be reached by hand without detaching the stretch ceiling.

Adjustable inset spots are generally compatible with BARRISOL. If the heat they diffuse is greater than 50°C, an insulating ring must be placed between the spot ring and the BARRISOL fabric. The spot power must not be greater than 50W.

Spots which transmit more than 60°C through their metal ring are incompatible with BARRISOL ceilings, even if they are equipped with insulating rings.

If mechanical ventilation is used, the air inlet and extraction flows must be designed correctly to ensure balance.

In buildings undergoing refurbishing work, the installation of BARRISOL stretch ceilings does not require that furniture be moved; however, it is the customer's responsibility to remove ornaments and plants from the room.

In addition, the customer should protect furniture using blankets or sheets (particularly lacquered or valuable furniture).



THE BARRISOL CLASSIC STRETCH CEILING SYSTEM

STRETCHED FROM WALL TO WALL ON VISIBLE TRACKS

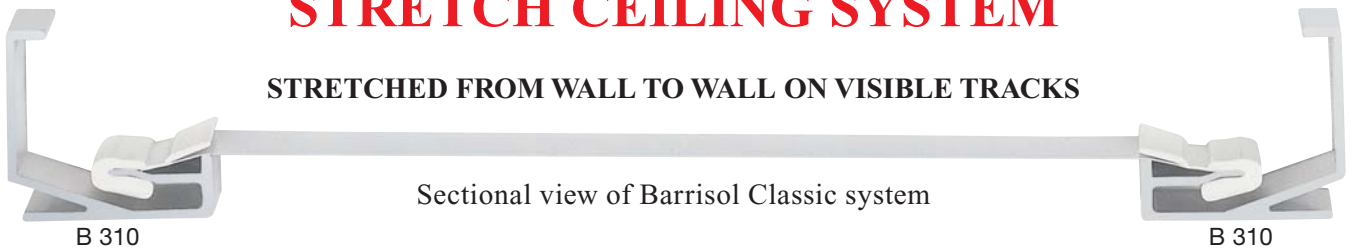

PRINCIPLE OF BARRISOL CLASSIC STRETCH CEILING SYSTEM

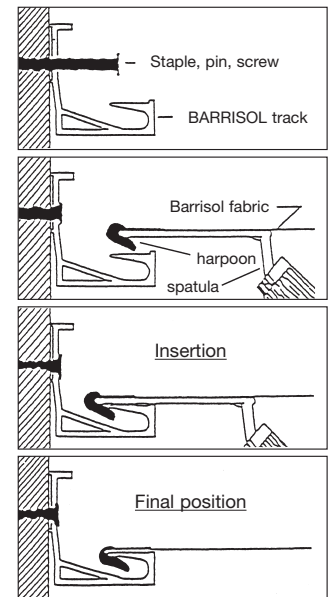
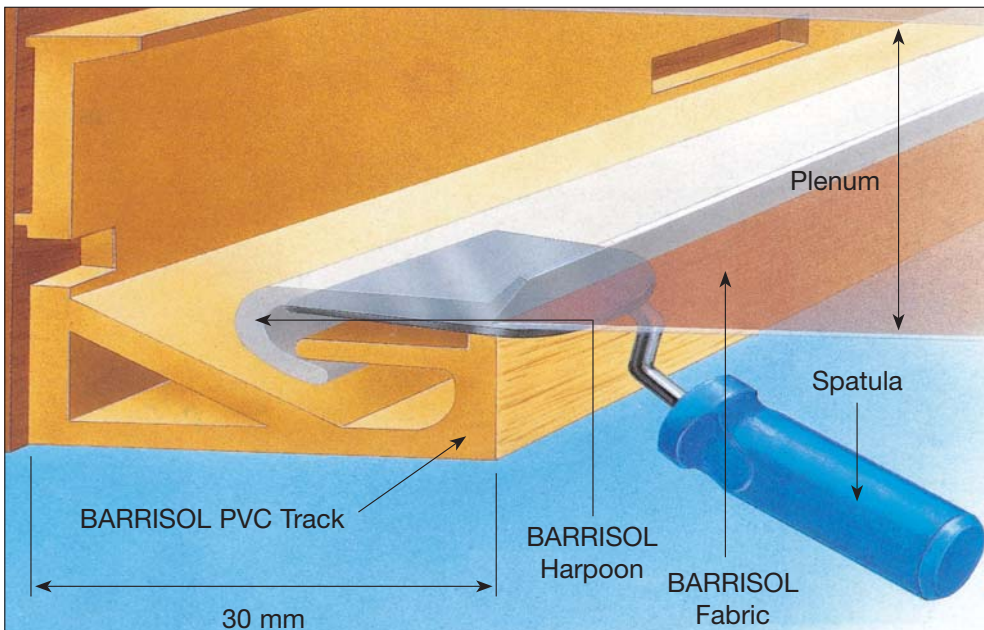

Sectional view of installation

The Barrisol Classic track is mounted on the periphery of the walls. Using the spatula, the harpoon, welded around the Barrisol Classic ceiling, is inserted to the track and is stretched. Installed wall to wall, Barrisol Classic lowers the room height easily. It does not stick to the existing ceiling. The air lock formed is equivalent to double-glazing.

CUSTOM-MADE



The measurements of the stretch ceilings are taken with a laser on site by Barrisol professionals, plotted on software, defined according to Barrisol standards and transmitted via Internet to the high-tech manufacturing software. The Barrisol Classic ceiling is adapted exactly to the perimeter of the rooms. The angles and curves which can be numerous, must be perfect and with no folds, the flatness of the ceiling depends on this accuracy. The seams of the strips and the harpoon are guaranteed 10 years.

BARRISOL CLASSIC STRETCH CEILINGS

71 angles and 3 curves

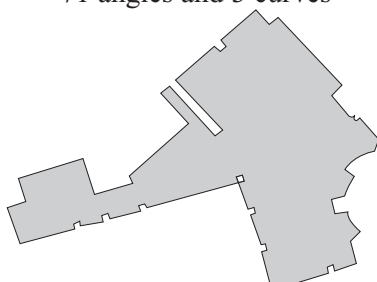

10 angles and a large curve

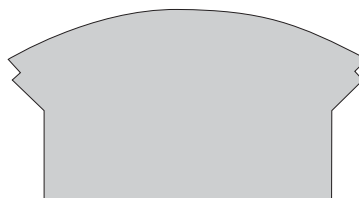

38 angles and 5 curves

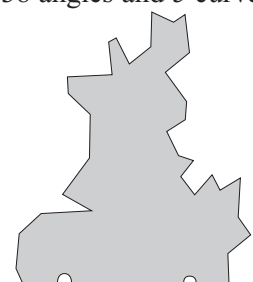

The most complex ceilings are manufactured to the shapes of the rooms to be equipped.

VISIBLE BARRISOL CLASSIC TRACKS

CHOICE OF DECOR:

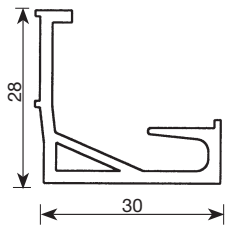

B 301

The Barrisol Classic PVC track

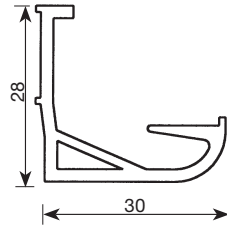

B 311

The Barrisol Rounded PVC track

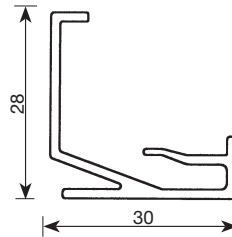

B 310

The Barrisol Classic aluminium track

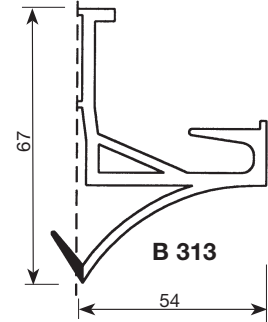

B 313

The Barrisol Cornice PVC track

CHARACTERISTICS:

PVC or aluminium track

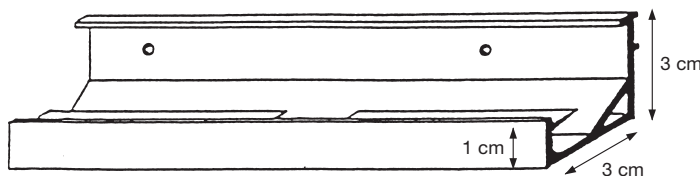

Curved Barrisol Classic track

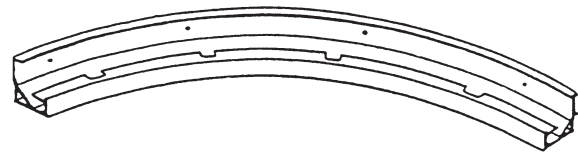

- extruded M1 white PVC tracks
- M0, aluminium, gold or bronze coloured anodised aluminium tracks
- machined to allow the ventilation of the plenum, balanced room and plenum air pressure
- notches for a quick assembly, easy disassembly which facilitates access to the plenum
- insertion of the Barrisol fabrics in the tracks by means of the harpoon
- no shade line on the walls
- possibility to paint tracks to match or contrast Barrisol colours
- view of the tracks after the installation on a width of 3 cm and a return of 1 cm, straight or rounded
- adaptation of the tracks to all perimeter configurations

- the curved PVC track is custom-made in the factory for an excellent finish
- diameter from 30 to 298 cm.
- can be painted, as for the PVC track, but after curving.

Exact angle join

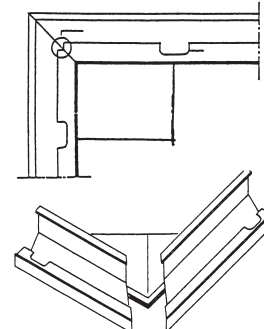

TRACK ATTACHMENT:

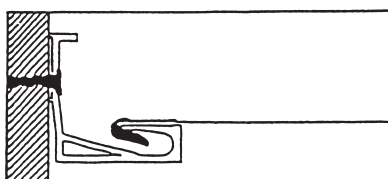

Stapled, screwed, riveted tracks depending on type of walls.

In any case, the tracks must withstand a tensile force of 30 kg/metre.

The tracks are fitted:

- on the periphery of the room
- at the desired height, taking into account the height of the technical equipment or lighting in the plenum.

Assembly with aluminium bracket

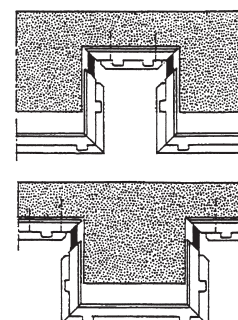



THE BARRISOL STAR STRETCH CEILING SYSTEM

WITH INVISIBLE TRACKS



BS 350/01

BS 350/01

Sectional view of system

INSTALLATION OF BARRISOL STAR STRETCH CEILINGS

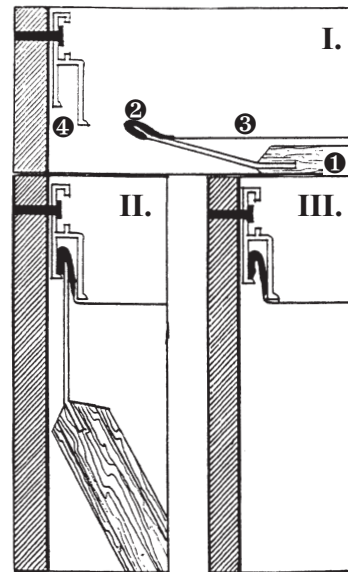

SECTIONAL VIEW OF THE INSTALLATION

I. Using a spatula (1), the harpoon (2), attached to the perimeter of the Barrisol Star ceiling (3), is guided in the direction of the track attached to the periphery of the room.

II. The harpoon is inserted into the track.

III. The-ceiling is stretched - the finish consists of a 6 mm decorative flash gap joint or with a joint cover.

3 - KINDS - OF BARRISOL-STAR tracks allow the fitting of the ceiling at different plenum heights or between cornices or at a distance from the wall.

THE BARRISOL STAR STRETCH CEILING SYSTEM benefits from all the advantages of Barrisol Classical, but it also offers higher performance: **BARRISOL STAR CEILINGS CONCEALED TRACKS.**

After installation, only a 6 mm decorative flash gap joint finish can be seen. The Barrisol Star ceiling benefits from extremely pure lines, without visible tracks. It can be used for all designs, even the most imaginative.

CUSTOM-MADE

Barrisol Star ceilings are custom-made according to exact data of the rooms to be equipped. Tracks and ceilings can be adapted perfectly to any perimeter.

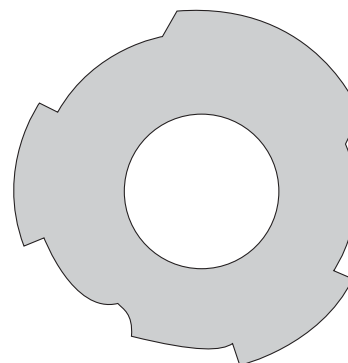
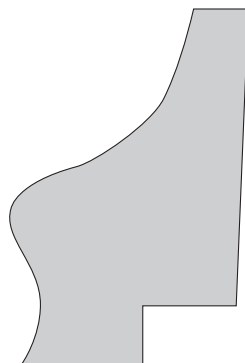
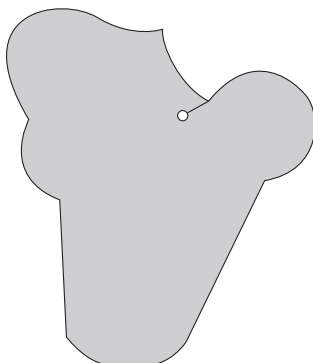

Barrisol Star ceilings are perfectly stretched.

LASER AND HIGH-TECH SOFTWARE



Laser measurements.
Software drawing plotting.
Transmission via Internet to manufacturing software.

BARRISOL STAR STRETCH CEILING TRACKS

INVISIBLE – ANODISED ALUMINIUM DECORATIVE FLASH GAP JOINT FINISH – M0
(Class O in UK, Class O in USA)

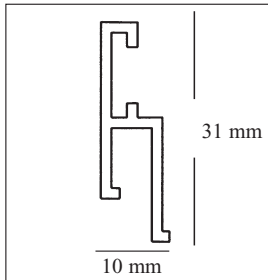

BS 350/01

To be fixed to wall

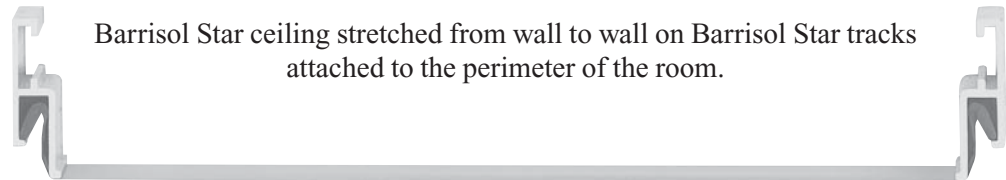

Barrisol Star ceiling stretched from wall to wall on Barrisol Star tracks attached to the perimeter of the room.

Any plenum height up to 32 mm from the existing ceiling

Option: PVC finishing joints



BS 350/011

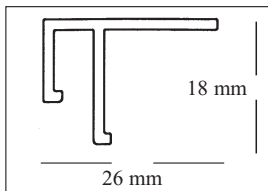

BS 350/11

To be fixed to ceiling

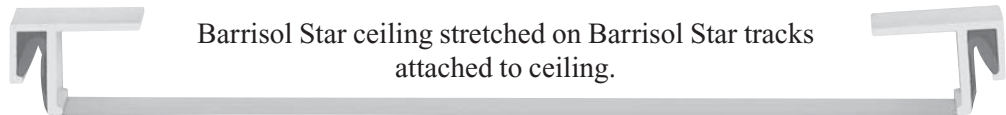

Barrisol Star ceiling stretched on Barrisol Star tracks attached to ceiling.

- for low plenum heights
- between cornices

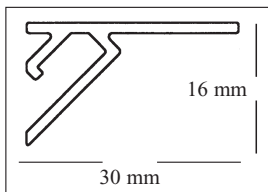

BS 350/202

To be fixed to ceiling

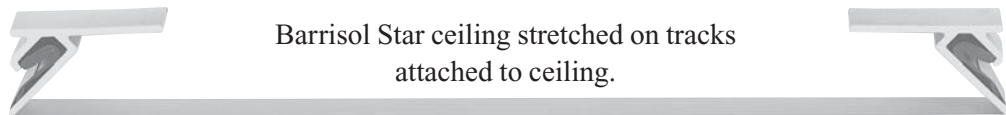

Barrisol Star ceiling stretched on tracks attached to ceiling.

The stretch ceiling must be at least 10 cm from the wall.

ROUNDED BARRISOL STAR TRACKS

- **CURVED** for 3D

Curved tracks custom-made in the factory

- for large curve and vault lengths
- for Barrisol Creaform

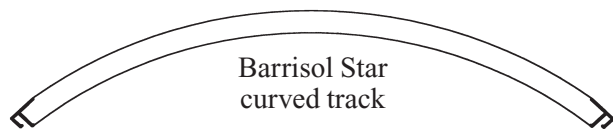

Barrisol Star curved track

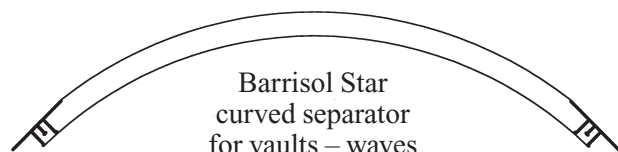

Barrisol Star curved separator for vaults – waves

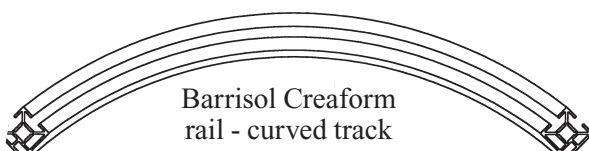

Barrisol Creaform rail - curved track

- **PRE-NOTCHED** for rounded shapes

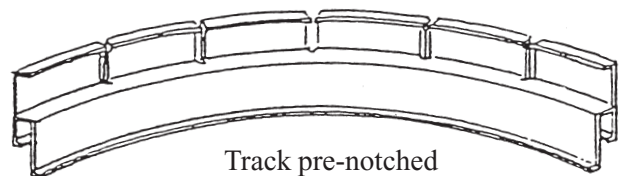

Track pre-notched in the factory for easy adaptation on site to rounded and vaulted shapes



Notched tracks to be fixed on rounded supports



Notched track and separator for vaults

CORNICES AND BEAMS

INTEGRATED CORNICE

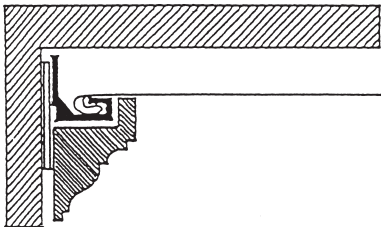

Composed of a Barrisol Classic track and cornice out of samba wood to be painted or varnished.

MOUNTED CORNICE

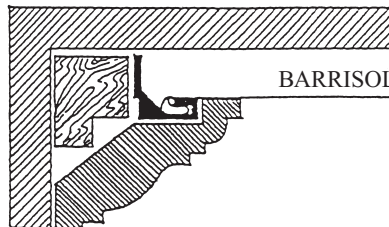

The Barrisol Classic installation adapts to the wooden plaster or polyurethane cornice

CORNICE WITH LIGHTING

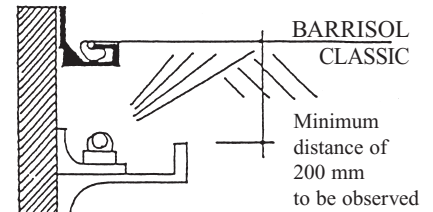

Lighting cornice, placed 200 mm from the wall, diffuses its light on the matt or satin ceiling

EXISTING CORNICES

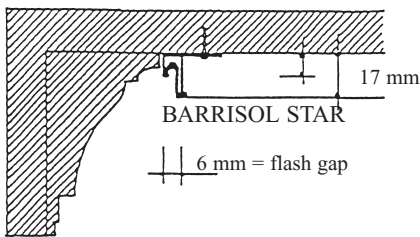

The Barrisol Star ceiling adapts to the height left by the shape of the cornice for its installation.

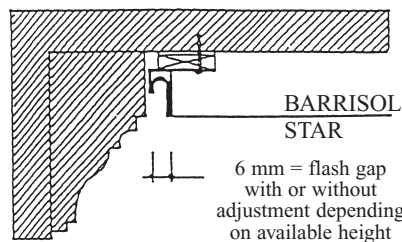

CEILING FIXED ONTO WALL LINING

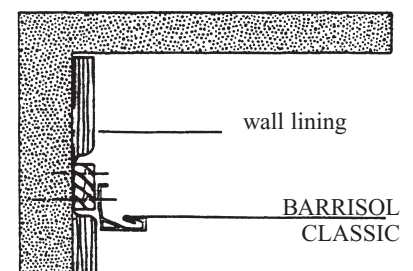

Barrisol Classic track fixed onto surface between lining

STRETCHED CEILING BARRISOL STAR BETWEEN BEAMS

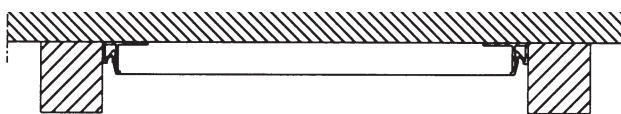

Barrisol Star tracks fixed to the existing ceiling. Stretched ceiling from beam to beam. 6 mm flash gap joint.

BEAM LINING



Rounded Barrisol edges

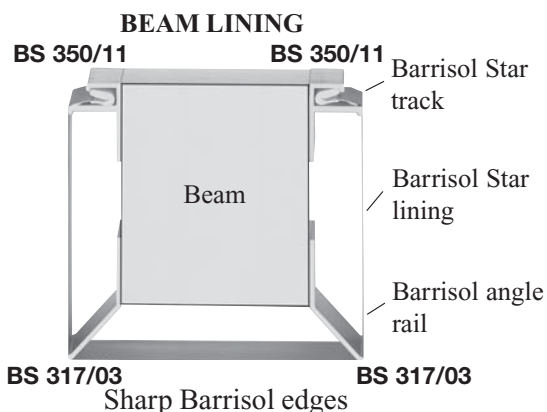

BEAM-CEILING JOIN

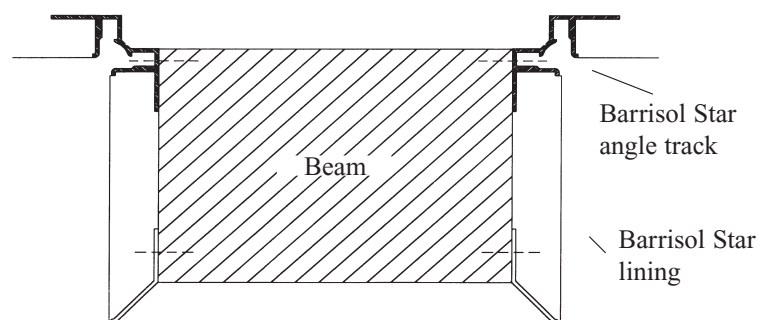

Join between Barrisol Star stretch ceilings and a lined Barrisol beam

INCORPORATION OF PIPES, PILLARS, COLUMNS

BARRISOL PIPE INCORPORATION SYSTEM

Resistant and aesthetic for a remarkable Barrisol Classic and Barrisol Star ceiling finish.
For water, electricity, heating pipes, etc.

- **Less than 3 cm from the wall**
on the periphery of the room (negates visible boxes)

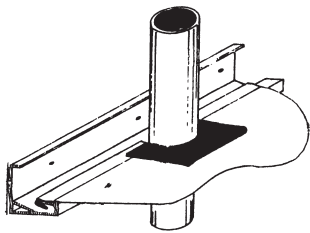

for one pipe

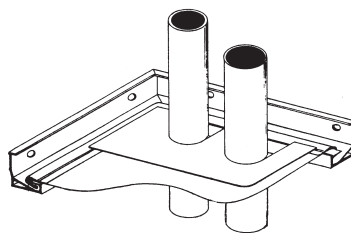

for 2 paired pipes

The stretch ceiling, reinforced with a resistant translucent panel, circumvents the pipes.
The system is not visible after installation.

- **More than 3 cm from the wall**

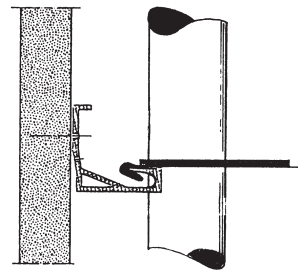

Stretch ceiling reinforced with a translucent panel and inserted into a Barrisol Classic track.

CURVED AND NOTCHED TRACKS FOR PILLARS AND COLUMNS

- **Diameter < 28 cm for:**
- Barrisol Classic
- Barrisol Star

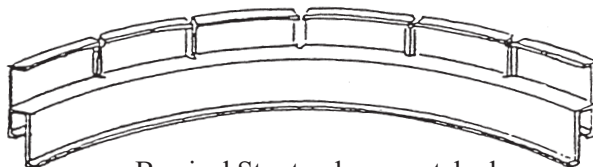

Barrisol Star track pre-notched
to fit the circumference of the pillars exactly.

Example of join between Barrisol Classic ceiling with trimming to pillar using notched Barrisol Star track.

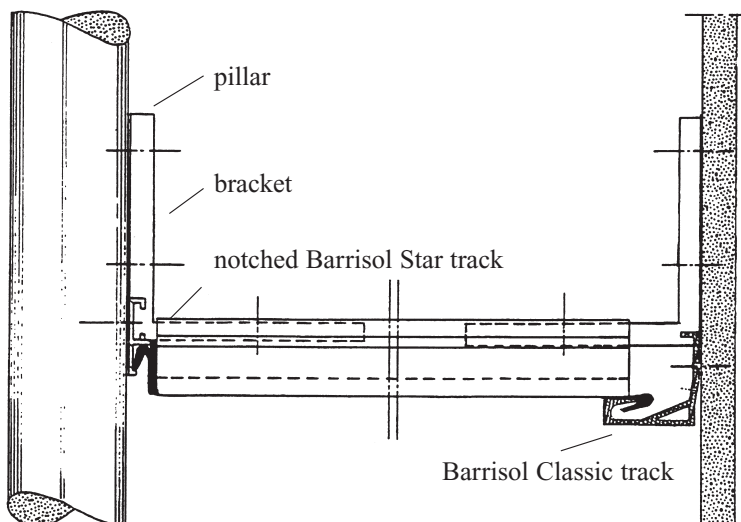

Sectional view

- **Diameter > 28 cm**
Barrisol Classic

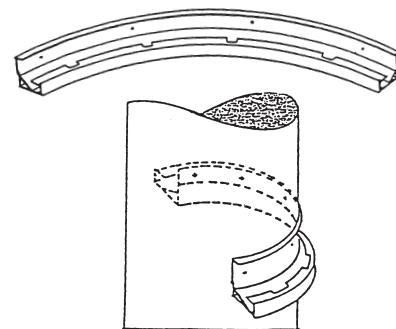

- Barrisol Classic PVC track curved in factory to the pillar and column measurements.
- Connection of the tracks by aluminium sleeve.

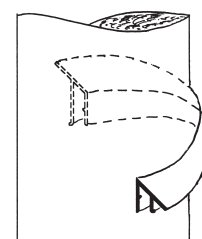

- Curved M0 aluminium Barriline track custom-made in factory to the pillar and column measurements.



INCORPORATION OF INSET DESIGNS & LOGOS

IN BARRISOL CLASSIC AND BARRISOL STAR STRETCH CEILINGS ACCORDING TO BARRISOL TECHNIQUES

EMBEDDING OF LOGOS

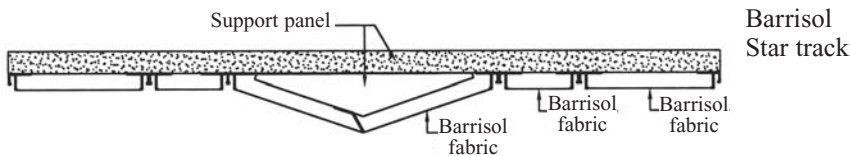

Embedding of MERCEDES logo in Barrisol Star stretch ceiling (sectional view)

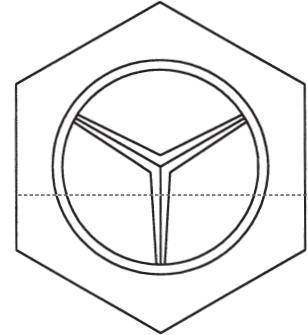

"Mercedes" logo produced in Barrisol Star stretch ceiling on Barrisol Star tracks

DUO BARRISOL STAR

Many decorative possibilities can be considered by installing a Barrisol Star ceiling in another Barrisol Star ceiling.

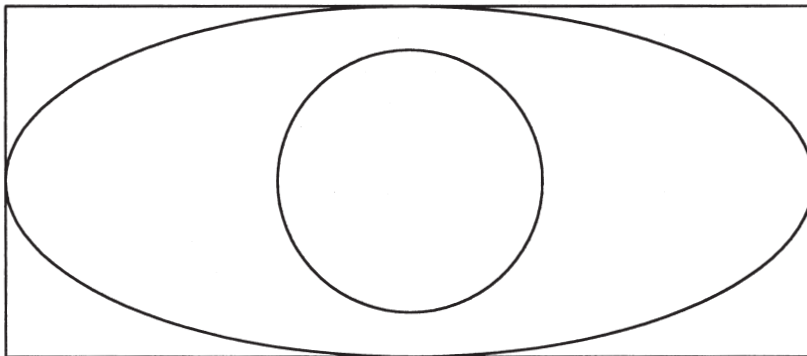

The Barrisol Star stretch ceiling can be square, rectangular, ovoid or any other shape. The two ceilings are stretched on Barrisol Star tracks

Sectional view of Duo Barrisol Star.

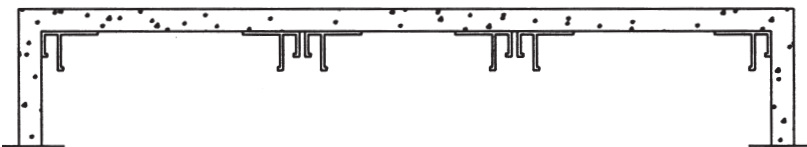

Barrisol Star tracks for incorporating Duo Barrisol Star

INCORPORATING A BARRISOL CEILING WITH PERIPHERAL UPWARD CURVE IN A BARRISOL STAR CEILING

Embedding of a round or oval Barrisol Star stretch ceiling with peripheral upward curve. Mini-spots or optical fibres can be incorporated.

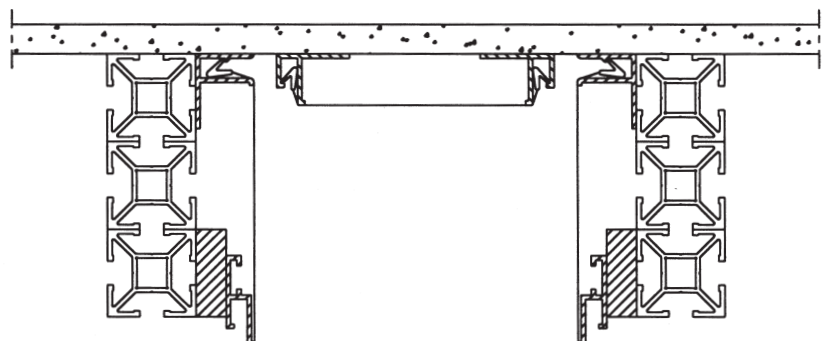

BARRISOL INCORPORATION

SKY-LIGHTS, ROOF WINDOWS, ROLLING SHUTTERS, INSPECTION PANELS IN BARRISOL CLASSIC AND BARRISOL STAR CEILINGS

ROOF WINDOW

between 2 Barrisol Star ceilings

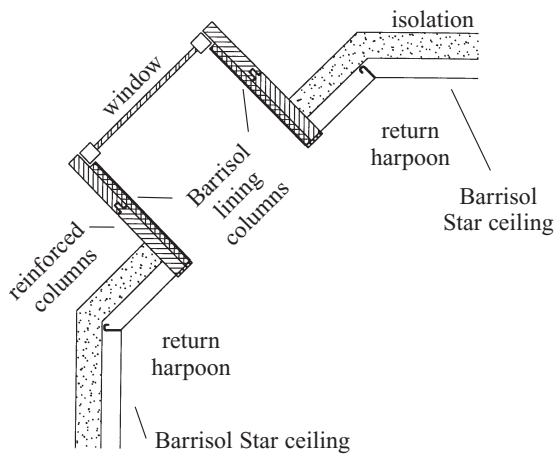

SKY-LIGHT

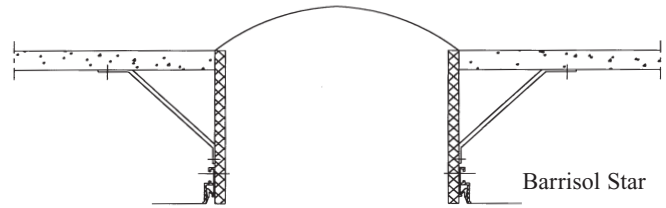

2 ceilings are inserted into tracks fixed on each reinforced column of the sky-lights which can be produced in various decorative shapes

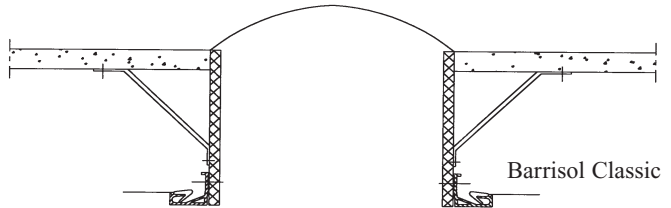

INSPECTION PANEL

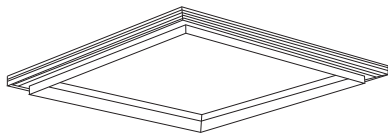

Barrisol fabric stretched on frame
or Barrisol Ceiling Tile

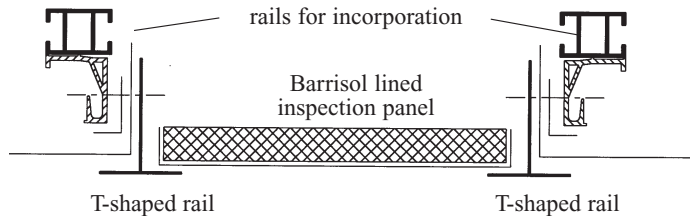

Support for inspection panel

ROLLING SHUTTERS

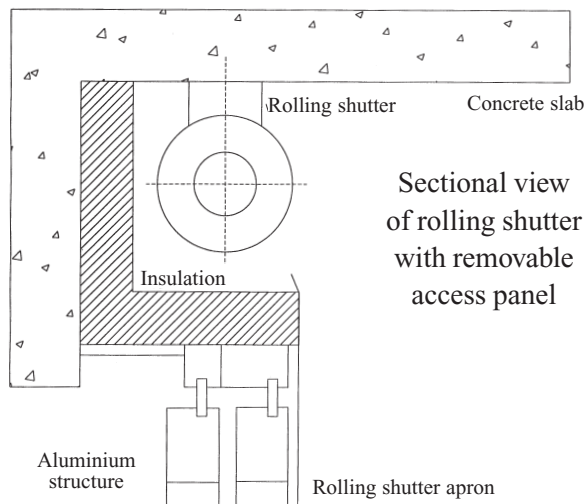

Sectional view
of rolling shutter
with removable
access panel

ROLLING SHUTTER REMOVABLE ACCESS PANEL (EXTERIOR)

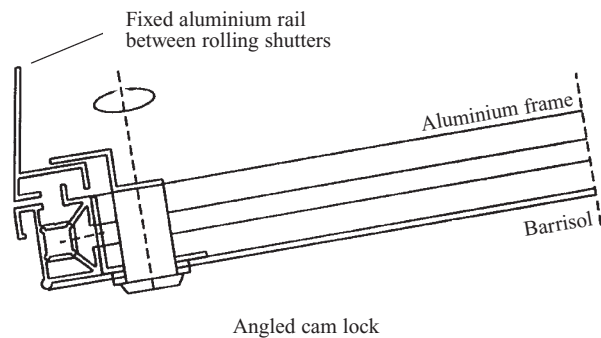

Angled cam lock

ALL TECHNICAL EQUIPMENT CAN BE INCORPORATED

IN BARRISOL CLASSIC AND BARRISOL STAR CEILINGS

Air conditioning or ventilation unit support

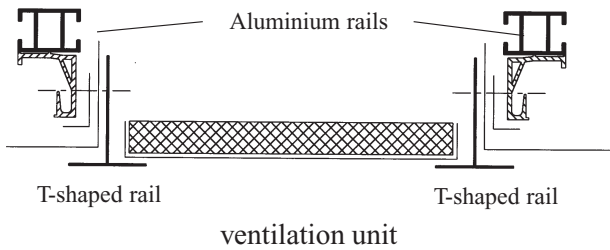

Technical device on perimeter of stretch ceilings.
Decorative finish.

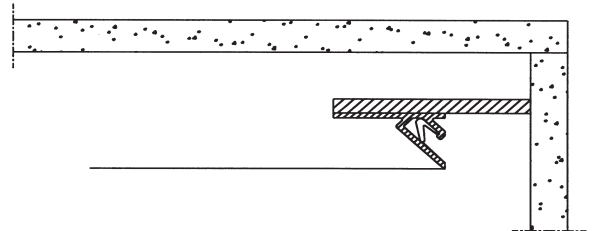

Air flow balancing system for ventilation in plenum

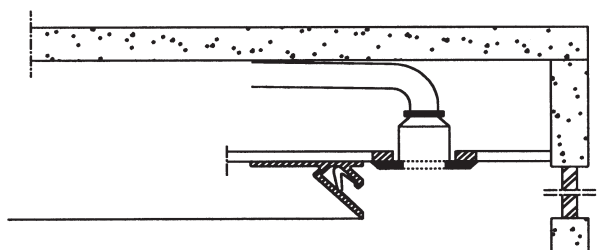
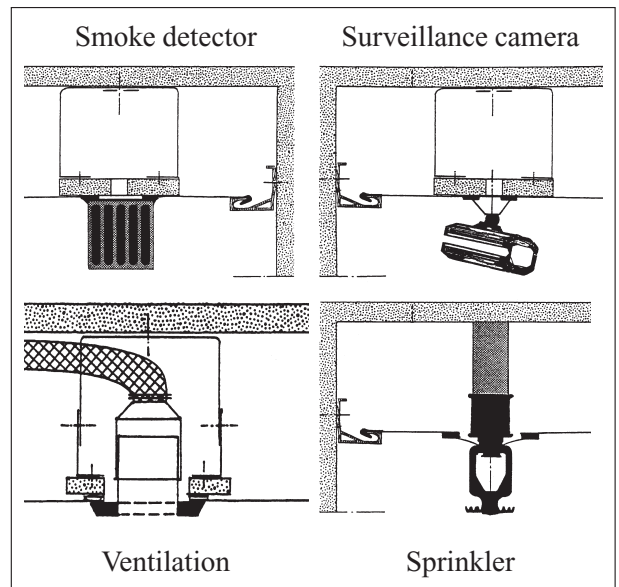
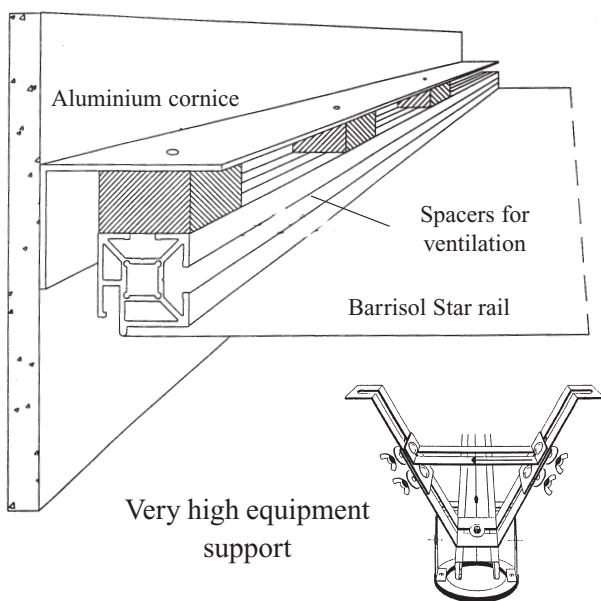

Air supply or extract system on glazed surfaces.

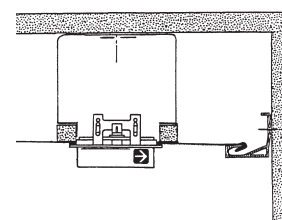

Stand alone safety light unit.

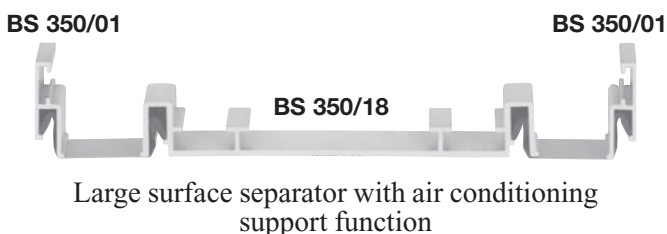
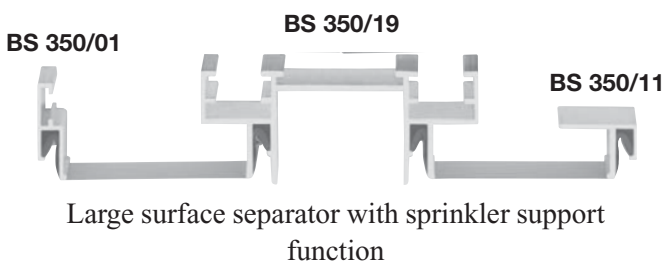

BARRISOL CLASSIC SLOPING CEILING SYSTEMS

SLOPING CEILING REFURBISHMENT TO FIT OUT ATTICS, CREATE NEW VOLUMES, LIVEN UP SPACES AND CREATE DECORATIVE ELEMENTS, WITHOUT ADDING WEIGHT TO EXISTING STRUCTURES.

THE RETURN HARPOON SYSTEM

Supports sloping stretch ceilings all along the edge.

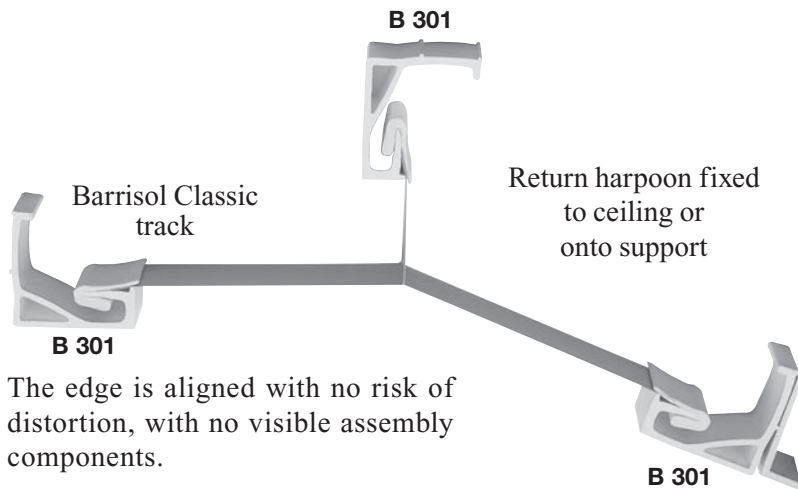

The edge is aligned with no risk of distortion, with no visible assembly components.

The return harpoon technique for sloping ceilings can be adapted to ceilings with 1, 2, 3 slopes or multiple slopes.

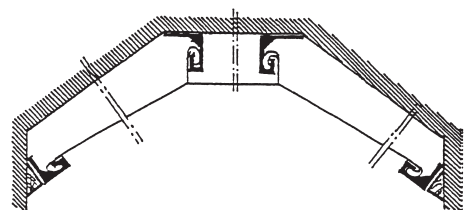
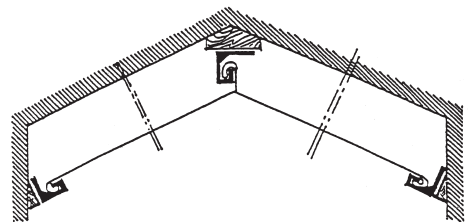
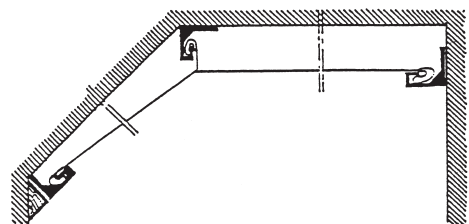
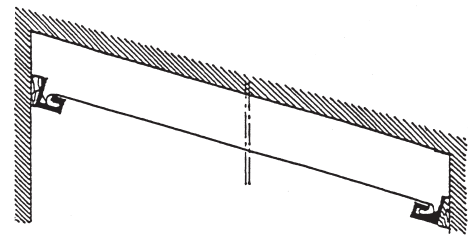

SUPPORT RAIL

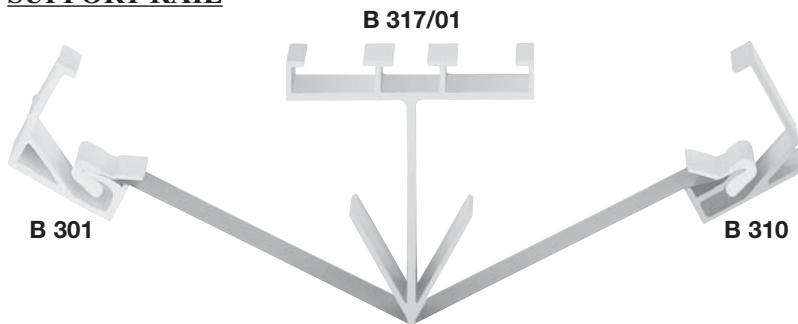

Multiple slope ceiling with support rail

CREATION

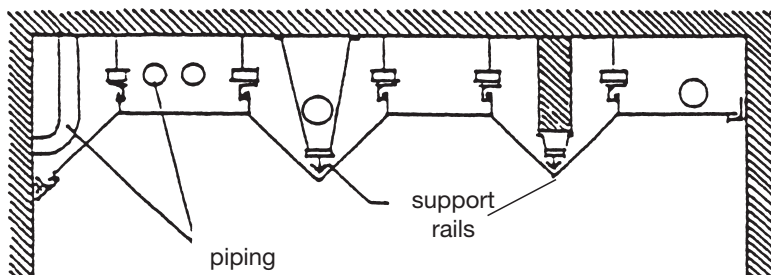

Architect: Marc Essartier

Decorative composition of sloping ceilings with return harpoons and support rails. Piping is placed in the plenum.

Heat insulation, soundproofing, plenum access are possible in all Barrisol Classic and Barrisol Star sloping ceilings.



BARRISOL STAR SLOPING CEILING SYSTEMS

BARRISOL STAR SLOPING CEILINGS

- Return harpoon and Barrisol Star track ((low plenum height)

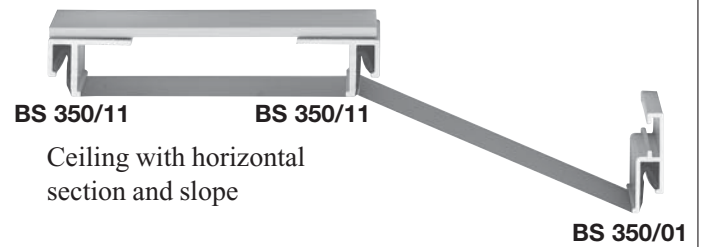

- Flash gap joint separator joining two slopes (low plenum height)



- Super Star separator (any plenum height)

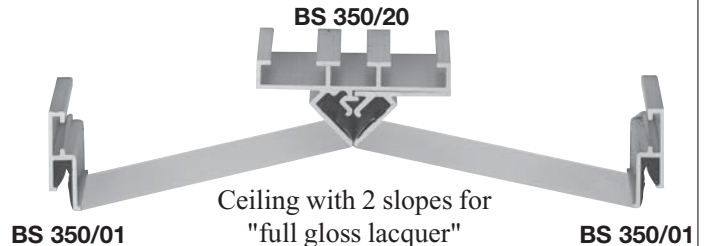

SUPPORT RAIL IN BARRISOL STAR CEILINGS

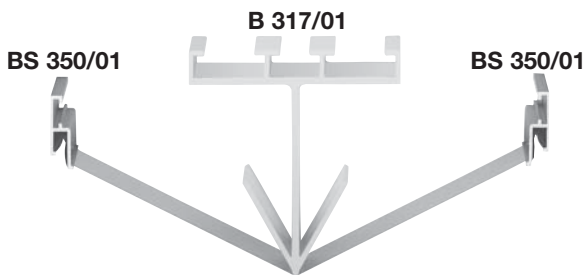

Barrisol Star ceiling from wall to wall, with change in slope using support rail

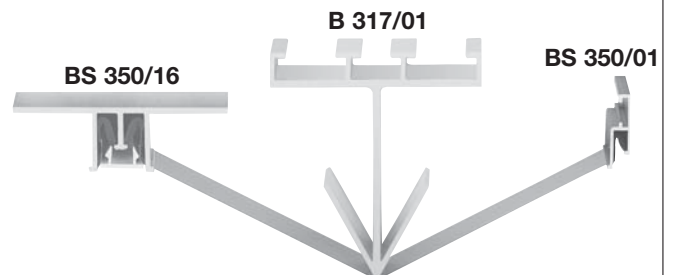

Barrisol Star ceiling from wall to separator, with change in slope using support rail

CREATION

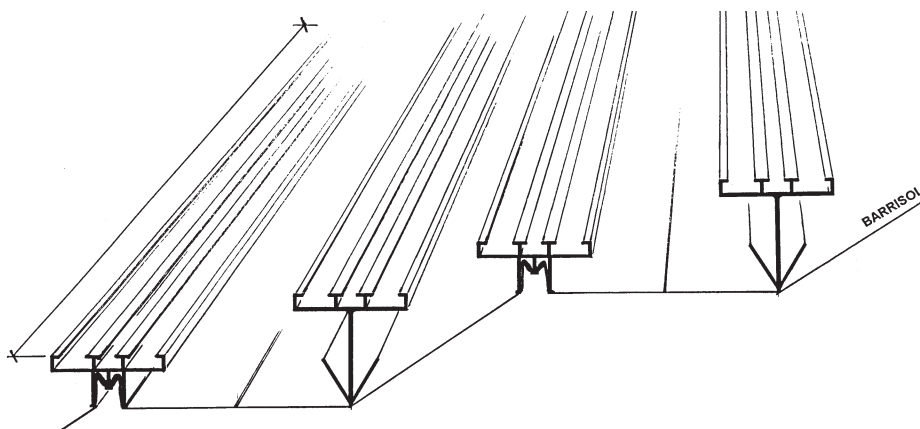

Composition of Barrisol Star ceilings mounted on Barrisol Star separator with change in slope using support rail.

STRETCH CEILINGS WITH RECESS

BARRISOL STAR STRETCH CEILINGS WITH SHARP EDGE ON RECESS

PLENUM HEIGHT
17,5 mm
(first solution)

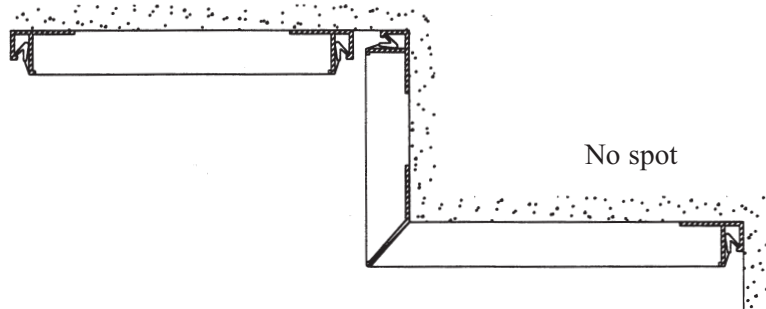

PLENUM HEIGHT
17,5 mm
(second solution)

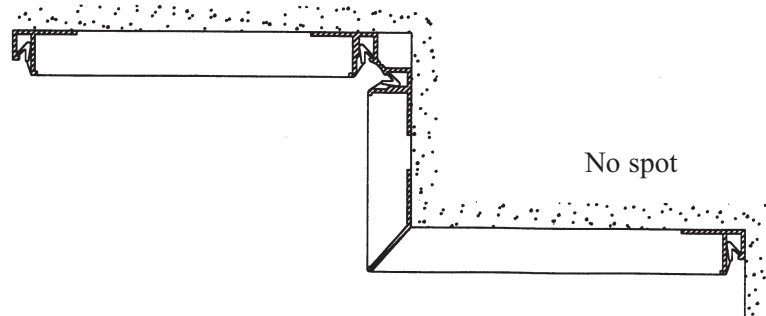

PLENUM HEIGHT
80 mm

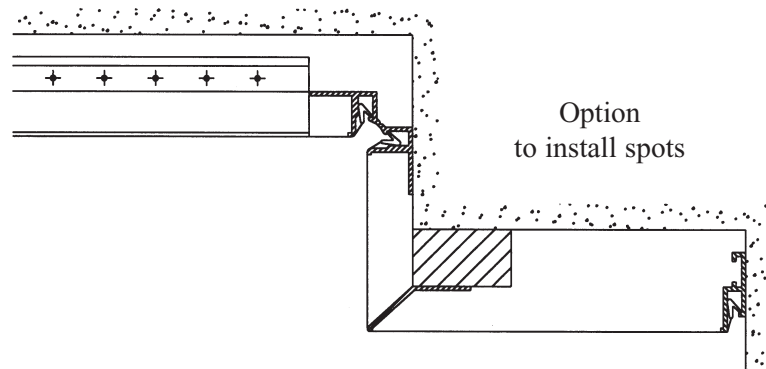

**CREATION OF STRETCH
CEILINGS WITH
RECESSES ON SYMA
ALUMINIUM STRUCTURE
AND GALVANISED STEEL
RAIL**

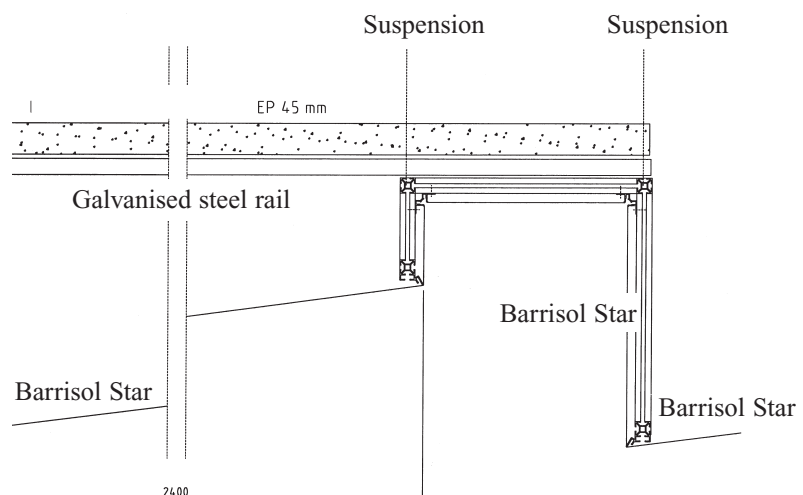



BARRISOL STAR 3D, THE 3D ARCHITECTURE STRETCH CEILING

WITH BARRISOL STAR 3D, STRETCH CEILINGS, WHICH WERE HORIZONTAL UP TO NOW, TAKE ON ALL THE ARCHITECTURAL SHAPES POSSIBLE.

USED IN MODERN ARCHITECTURE, BARRISOL 3D ALSO REFURBISHES ALL STYLES, RESPECTING THE ORIGINAL ARCHITECTURE



Restoration of top and side surfaces in Versailles church

Architect: STDE 2A, Yves Durand

Orange florès Barrisol Star 3D stretch ceiling following the shapes of the curves formed by the vaults, respecting the original architecture.

Duration of Barrisol work: 3 weeks

Restore architectural forms

- Barrisol 3D conceals the tracks out of sight to show the original architecture.
- The ceiling, custom-made in 3D, fits exactly to all the kinds of vaults, semicircular arches, ribs, three and five-sided structures, small vaults, overhangs and all architectural forms. Barrisol 3D allows for the reconstruction of simple arches, vaults, domes or complex forms and shapes.

A universal and harmonious covering product

For ancestral covering products, requiring long replacement times which can be easy to damage, Barrisol offer an excellent substitute in the matt and satin finishes. Smooth, uniform, non-reflecting, impermeable, quick-installed, the Barrisol 3D products offer a spectacular and durable result, in perfect harmony with the architecture.

Barrisol 3D:

Meets all the conditions to ensure successful and durable 3D architecture ceilings in all styles.

BARRISOL STAR 3D TRACKS

CURVED BARRISOL STAR TRACKS, DOUBLE TRACKS ARE CUSTOM-MADE IN THE FACTORY OR PRE-NOTCHED

CURVED BARRISOL STAR TRACKS

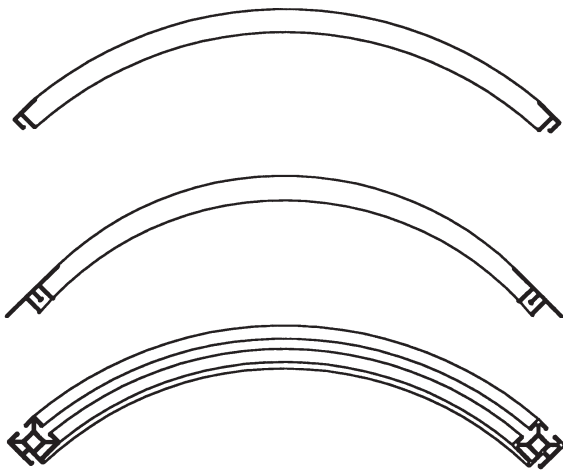

Curved tracks custom-made in the factory

NOTCHED BARRISOL STAR TRACKS

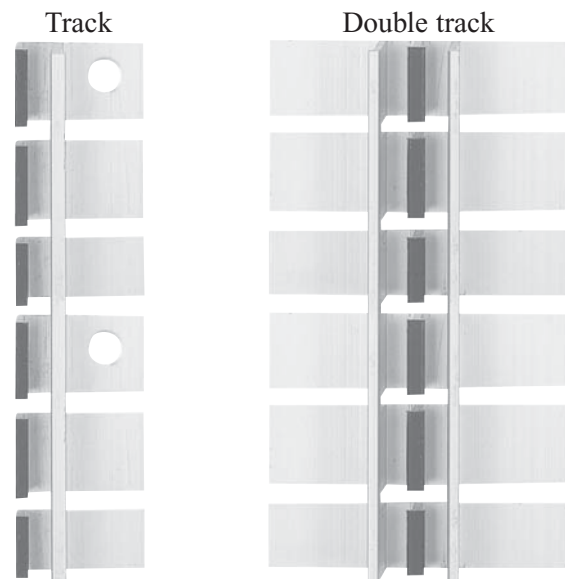

Tracks pre-notched in the factory to adapt to curved lines exactly

TRACKS AND SHAPES

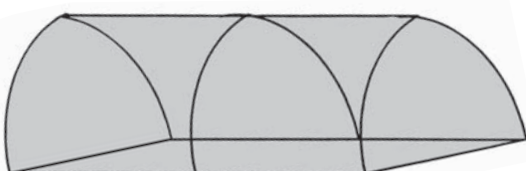
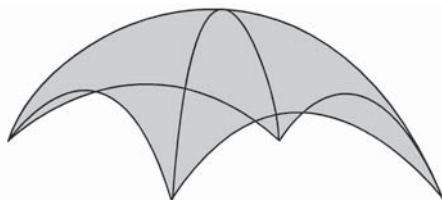
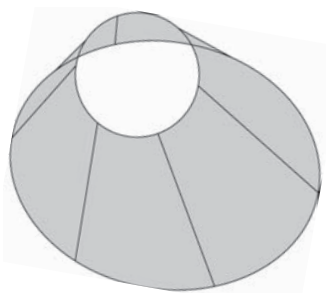

3D REFURBISHING

Barrisol's extremely advanced techniques can be adapted to the requirements and special needs of the surfaces to be refurbished.

- edge reinforcement in the event of decay
- retention of particles liable to fall from existing ceiling.

The Barrisol Star 3D ceiling does not stick to the existing ceiling, allows the installation of heat insulating and soundproofing materials, and prevents stains caused by damp.

The different Barrisol tracks and rails can be used with any type of architecture.

The Barrisol fabric range offers the most suitable texture and colour for all locations and all materials.

The refurbishing work is durable with an exceptional finish.



BARRISOL STRETCH CEILING INSTALLATION TECHNIQUES FOR LARGE SURFACES

- STANDARDISED BARRISOL STRETCH CEILINGS DIMENSIONS
- SEPARATORS TO INSTALL BARRISOL STRETCH CEILINGS OVER UNLIMITED SURFACES

Stretch ceilings must have a maximum flatness. Since the dimensions of each ceiling vary, Barrisol set measurement standards which represent the highest value for each ceiling.

These standards are defined, not by self-supporting surfaces, but by length and width ratios, given in the table below.

TEXTURES		MAXIMUM LENGTHS AND WIDTHS	
		Length	Width
METALLIC LACQUER	Any height	20 m	4.5 m
		6 m	5.5 m
MATT SATIN	<3.50m	20 m	4.5 m
		6 m	5.5 m
	>3.50m	20 m	4.5 m
		10 m	5 m
BRUSHED SUEDE	Any height	15 m	4 m
		10 m	4.5 m
		5 m	5 m

LARGE SURFACES

If the dimensions of the ceiling surfaces to be installed are greater than Barrisol standards, the Barrisol Large Surface Technique is used.

DIVIDING LARGE SURFACES

- The surface to be equipped is divided into one or more ceilings meeting Barrisol standards.
- The range of separators including Barrisol Classic, Barrisol Star, Barrisol Super Star, Light strips, Ceiling with braids, is used for this division.

BARRISOL SEPARATORS

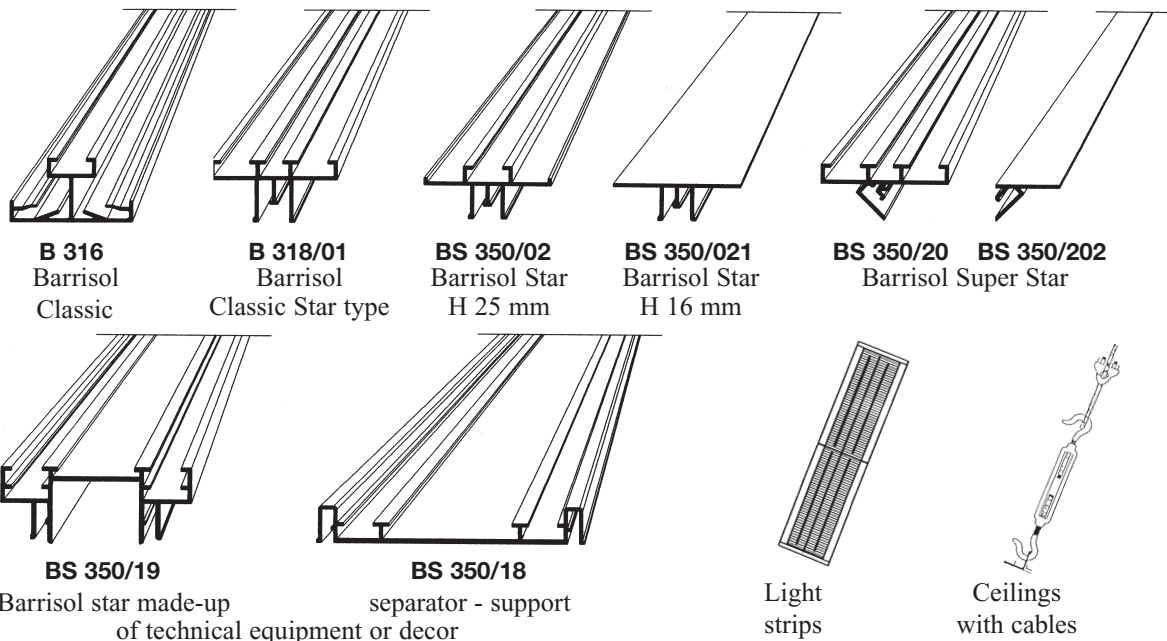

BARRISOL CLASSIC AND BARRISOL STAR SEPARATORS

CAN BE INSTALLED IN UNLIMITED NUMBERS
AT DIFFERENT PLENUM HEIGHTS
M0 anodised aluminium

BARRISOL CLASSIC SEPARATOR

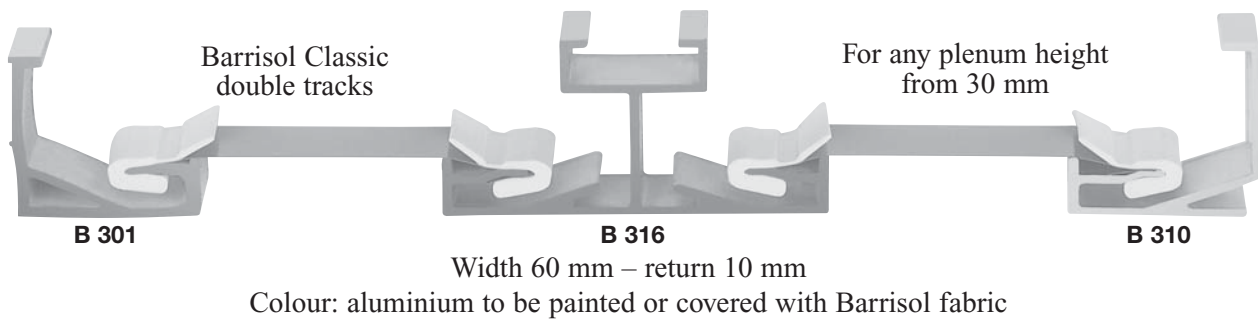

BARRISOL CLASSIC STAR TYPE SEPARATOR

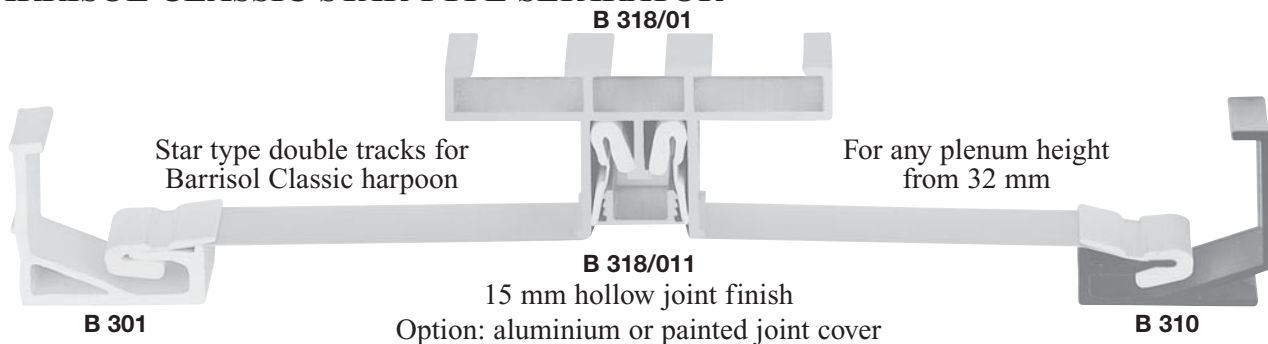

BARRISOL STAR SEPARATOR TO BE FIXED TO WALL

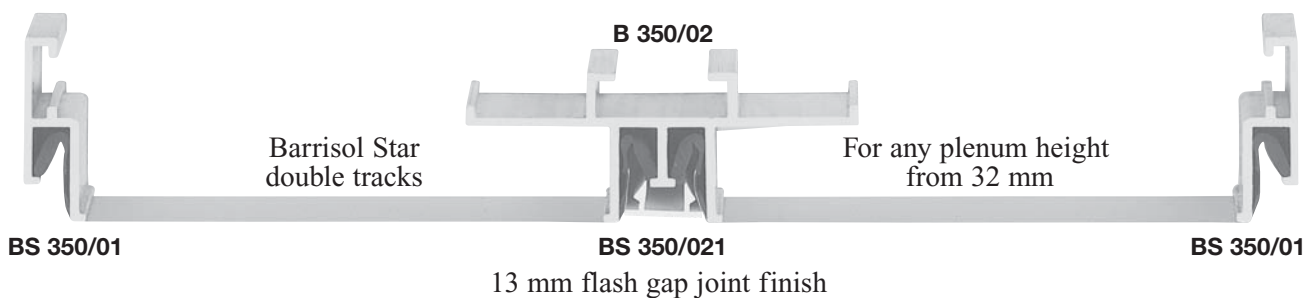

BARRISOL STAR SEPARATOR TO BE FIXED TO CEILING

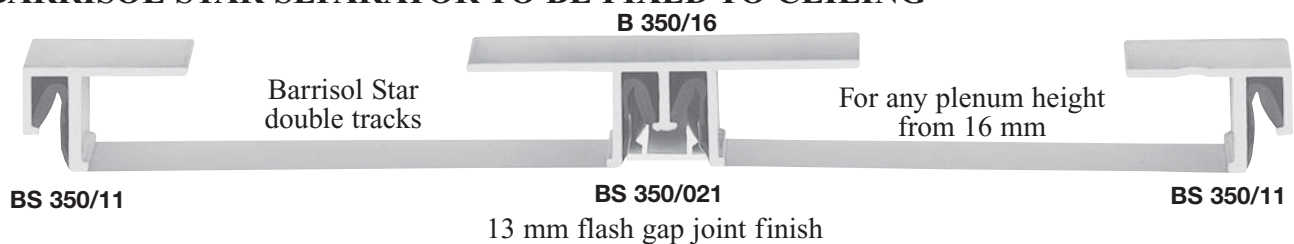

OPTION FOR BARRISOL STAR SEPARATORS

- aluminium or painted joint cover to be installed in recess
- PVC joint cover flush with separator.



BARRISOL SEPARATORS AND CABLE SYSTEM

BARRISOL SUPER STAR SEPARATOR

To separate a surface into 2 standardised Barrisol ceilings



The Super Star separator is composed of 2 parts. The first ceiling is inserted into the left part.



The second ceiling is inserted into the right part. Both separators together enclose the 2 ceilings.

This separator is invisible. The finish consists of a Barrisol seam in appearance.

COMBINATION OF SEPARATOR-TECHNICAL EQUIPMENT SUPPORT OR DECOR

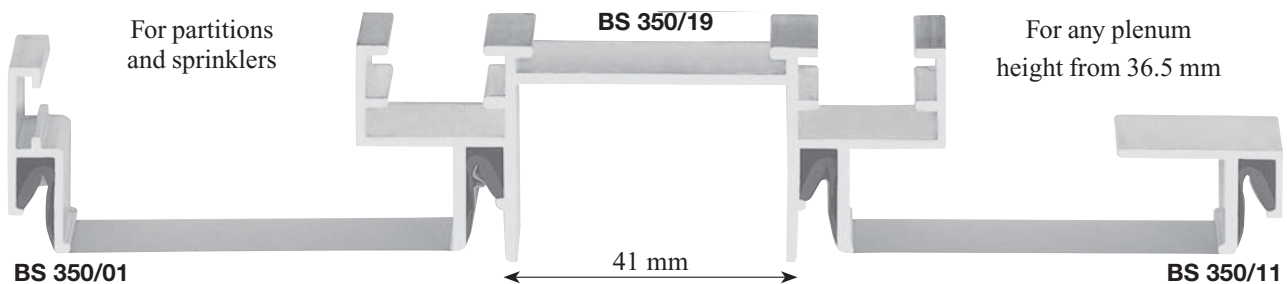

COMBINATION OF SEPARATOR-TECHNICAL EQUIPMENT SUPPORT OR DECOR

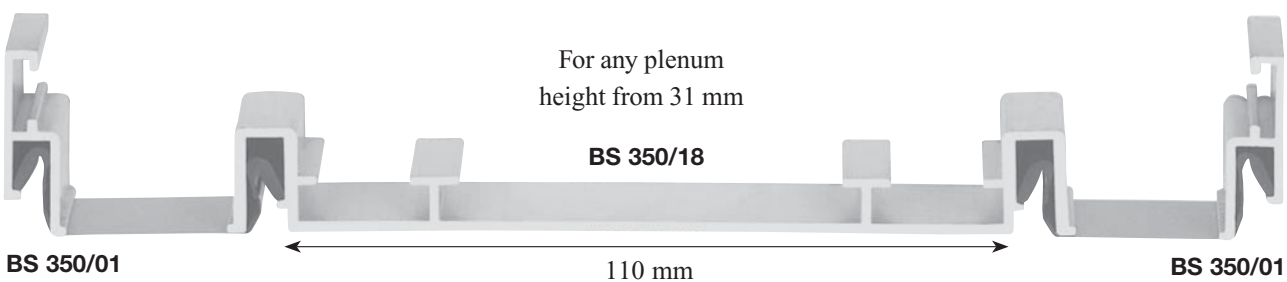

CEILING WITH CABLE SYSTEM

Invisible, wall-mounted large surface ceiling reinforcement

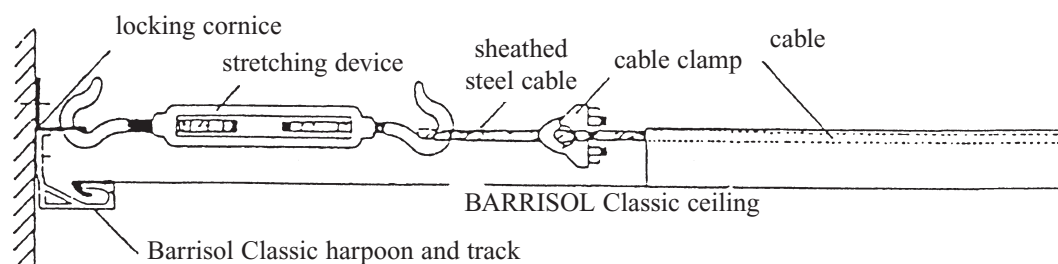

The Barrisol Classic or Barrisol Star ceiling is reinforced at each seam with a second seam positioned 25 mm above it, forming a piping in which the steel cable attached to the stretching device fixed to the wall is inserted. The stretched ceiling is levelled by stretching the cable using the stretching device. For matt and satin textures.

LIGHT STRIP SEPARATORS
(NOT AVAILABLE IN CANADA OR THE USA)

SEPARATOR AND LIGHT SOURCE ROLLED INTO ONE

BARRILEC UNO:

Light strip elements with built-in interlocking system, with high reflection power and low luminance.

2 lengths

- 1525 x 250 x 100 mm
- 1255 x 250 x 100 mm

Removable end fittings

- With Barrisol Classic interlocking system
- At 2 ends of a Barrilec Uno assembly

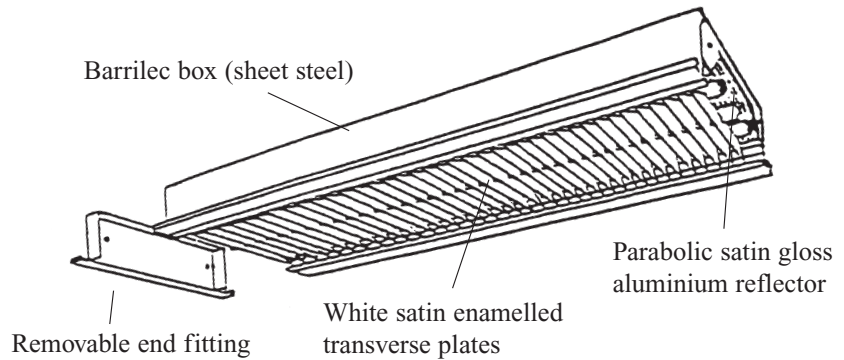

2 or more Barrilec Unos can be aligned in light strips

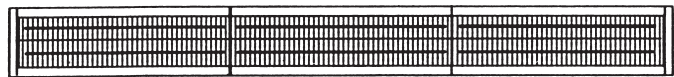
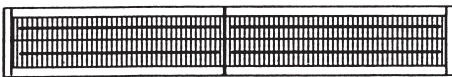

BARRILEC ECO:

Economical light strip with built-in interlocking system, without reflector

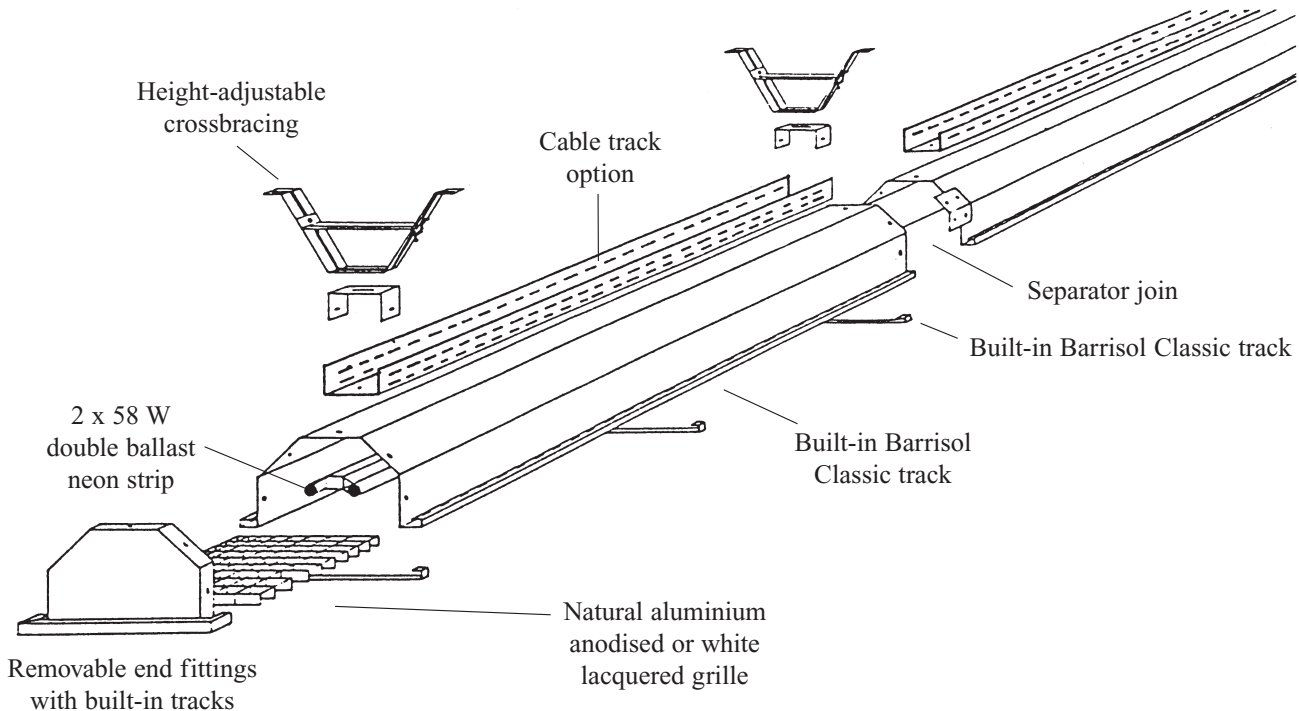



INSTALLING STRETCH CEILINGS ON LARGE AREAS

BARRISOL CLASSIC – BARRISOL STAR – BARRISOL TREMPO

CREATING A STABLE AND RESISTANT ASSEMBLY

Barrisol materials and techniques for large surfaces make it possible to install a stable and resistant assembly for stretch ceiling applications. The tracks are fixed over the entire perimeter to be installed. The separators are connected to the tracks on the periphery and to each other at their join. The stretch ceilings interlock in the spaces created..

SEPARATOR CONNECTION AND JOINING ACCESSORIES

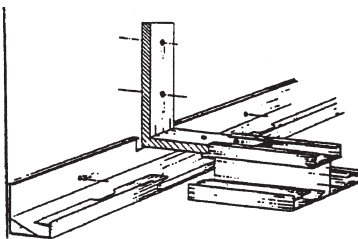

Barrisol separator fixed on
Barrisol Classic tracks

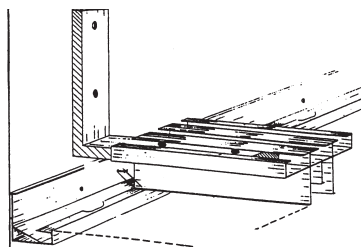

Barrisol Star separator fixed on
Barrisol Classic tracks

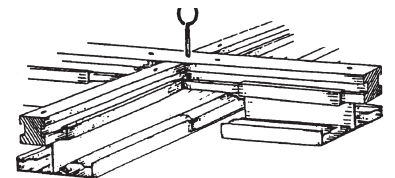

Join of 2 separators

SEPARATOR INSTALLATION ACCORDING TO PLENUM HEIGHT

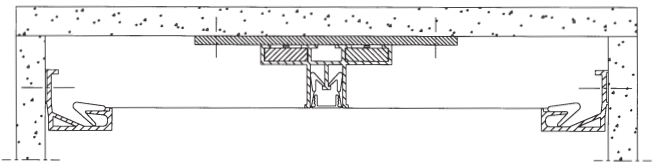
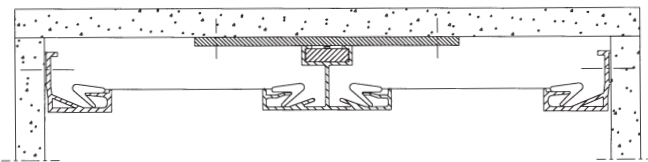

Low plenum height: the separator is fixed to the ceiling

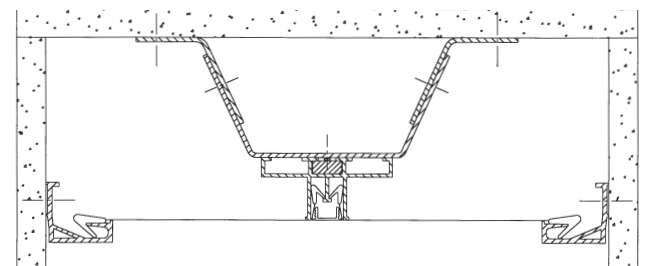
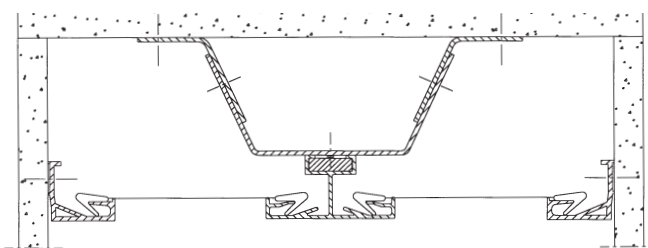

High plenum height: the separator is fixed to the ceiling, at regular intervals, with an adjustable device.

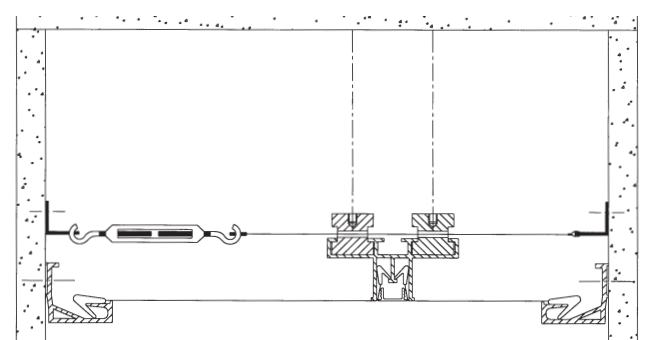
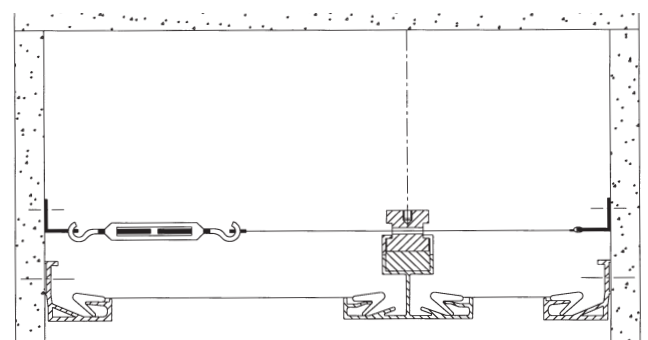

Very high plenum height: the separator is fixed at regular intervals to the ceiling with steel cables and to the wall with stretching devices.

LARGE SURFACE DESIGN

TECHNIQUES AND AESTHETICS

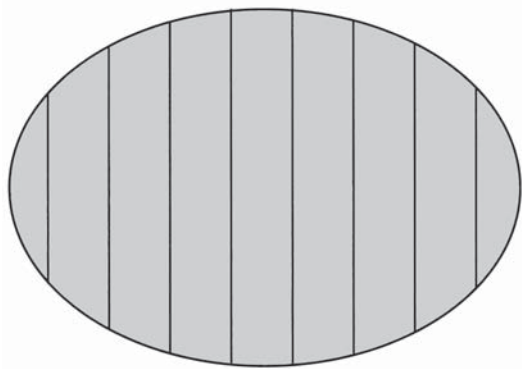

650 m² Barrisol Classic ceiling in 9 parallel ceilings contained in an oval installed at Ebingen (Germany)

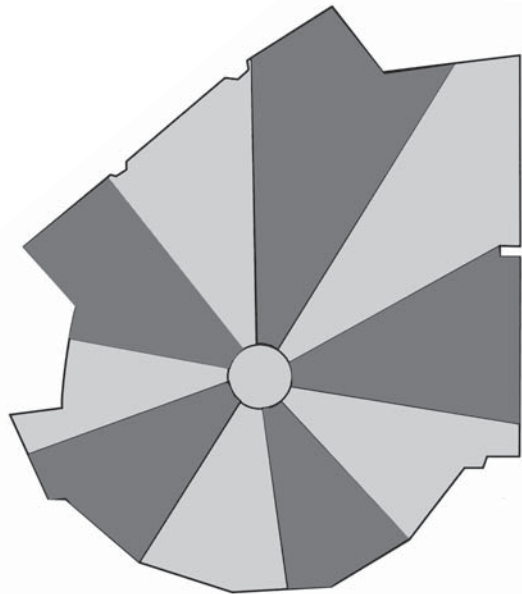

650 cm² brushed suede Barrisol ceiling, 2 colours, installed at Territet (Switzerland)

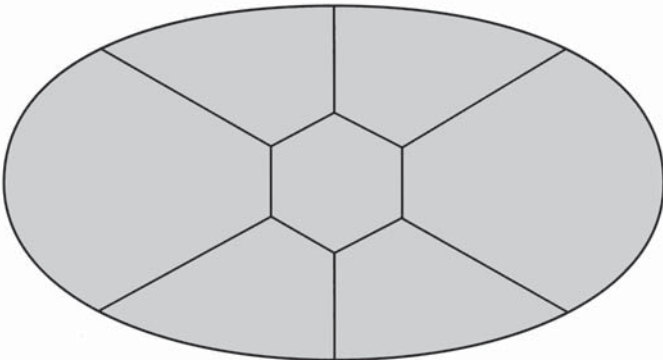

450 m² Barrisol ceiling, 30 m long, in 7 parts, installed at a height of over 10 m at Namur (Belgium)

- Separators divide a surface, of dimensions greater than Barrisol standards, into 2 or more ceilings.
- The separators form a grid, a plane or 3D geometric figure depending on the determined design and delimit the dimensions of each stretch ceiling.
- The division of large surfaces, which may form square or rectangular ceilings, may also create decorative designs.
- Geometric figures for Barrisol Classic.
- All shapes and sizes for Barrisol Star

Examples of separations of large surfaces with Barrisol Classic and Barrisol Star separators.

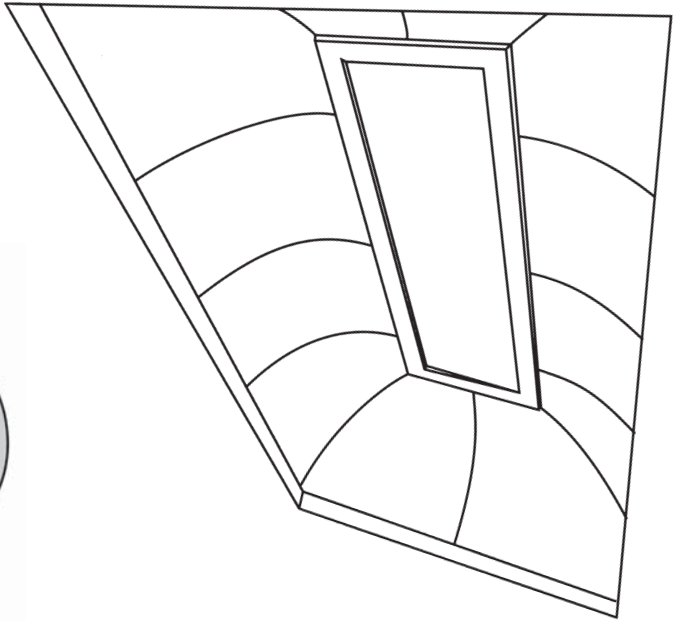

Stretch ceiling prototype installed at the City Hall in Compiègne (France)



LIGHT SOURCE INTEGRATION AND SUSPENSION IN BARRISOL UNIVERSE STRETCH CEILINGS

(NOT AVAILABLE IN CANADA AND THE USA)

BARRISOL TECHNIQUES ENSURE STABLE AND AESTHETIC INSTALLATION FOR ALL TYPES OF LIGHTING INCORPORATED IN BARRISOL UNIVERSE STRETCH CEILINGS.

BARRISOL UNIVERSE STRETCH CEILING SPOTS

SPOTS COMPATIBLE WITH BARRISOL STRETCH CEILINGS:
BARRISOL SPOTS and, as a general rule, **ADJUSTABLE SPOTS < 50°C**
5 W MINI-SPOTS, IODIDE SPOTS, OPTICAL FIBRES.

BARRISOL

**In 2
diameters**

SPOTS

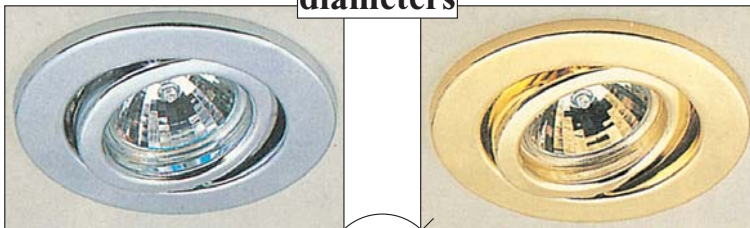

silver chrome

gold chrome

Inner
80 93
Outer

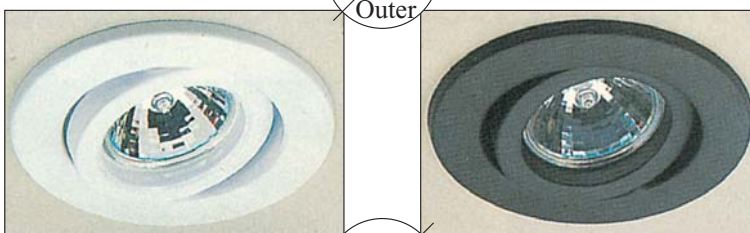

white

black

Inner
90 110
Outer

Spots tested and approved for their compatibility with Barrisol stretch ceilings.

BARRISOL SPOTS

- Do not transmit their heat to Barrisol stretch ceilings
- Do not overheat the plenum
- Technical characteristics
 - adjustable
 - halogens
 - intensity 12 V
 - power < 50 W
 - 50 mm diameter glass bulb
 - diffusion of light downwards

INSTALLATION

Spots are installed in Barrisol stretch ceilings using **Barrisol spot supports**.

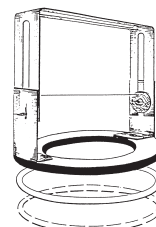

OTHER SPOTS

Spots from 50 to 60 °C must have an insulator inserted between the spot plate and the Barrisol stretch ceiling.

INCOMPATIBLE SPOTS

Spots > 60 °C.

BARRISOL SPOT INSTALLATION TECHNIQUES

BARRISOL STRETCH CEILING SPOTS ARE CONNECTED TO THE EXISTING CEILING USING THE PATENTED BARRISOL SPOT SUPPORT

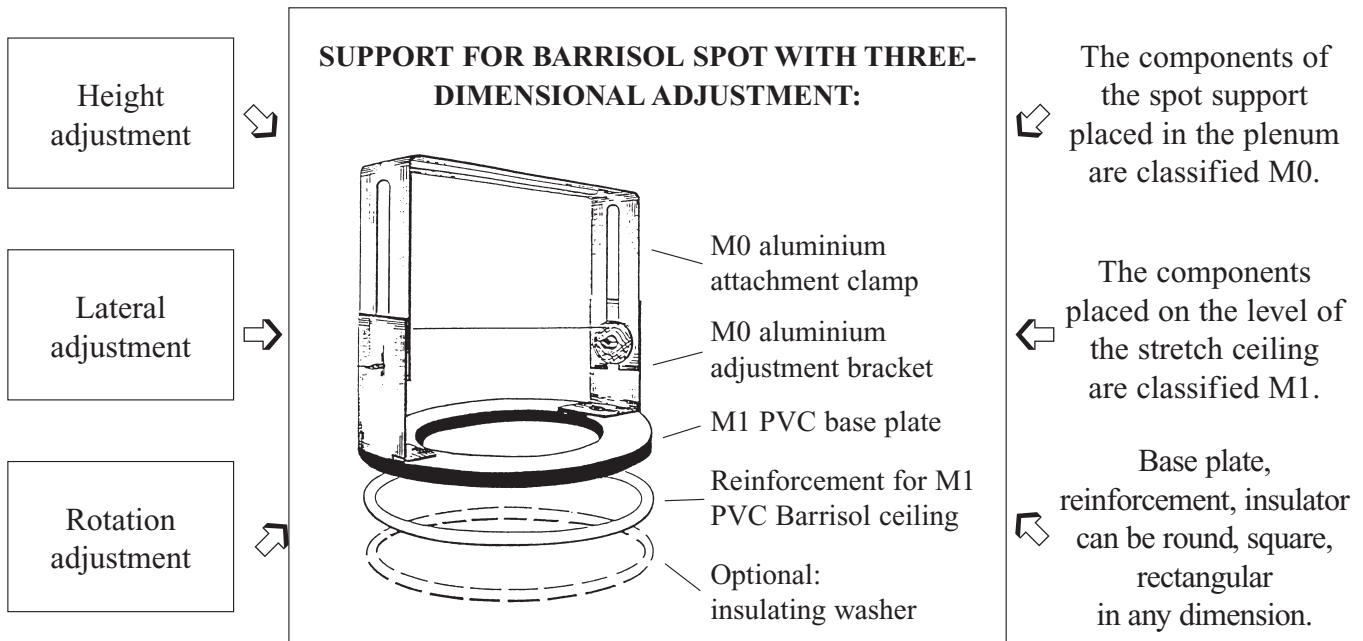

The Barrisol spots are perfectly aligned with the Barrisol ceilings, straight or curved and flush with slopes.

ADJUSTABLE BARRISOL SPOT SUPPORTS AT ANY PLENUM HEIGHT

The -adjustment plates connect the spot to the existing ceiling according to the plenum height.

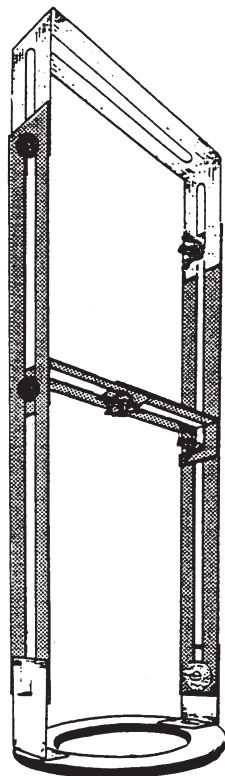
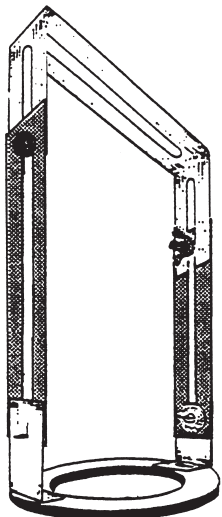

Combined attachment of several spots for high heights

Barrisol spot supports placed on rails fixed at regular intervals, using adjustable crossbracing, to the existing ceiling.

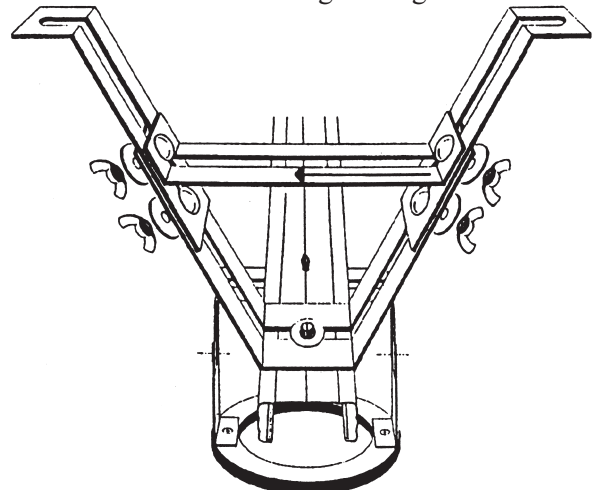

THE BARRISPOT SYSTEM
(NOT AVAILABLE IN CANADA OR THE USA)

SAFETY AND QUICK INSTALLATION

THE BARRISPOT, SPOT, SPOT SUPPORT, TRANSFORMER, ROLLED INTO ONE.

The spot support, which connects the spot to the existing ceiling, is cradle-shaped to receive the transformer.

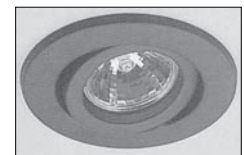
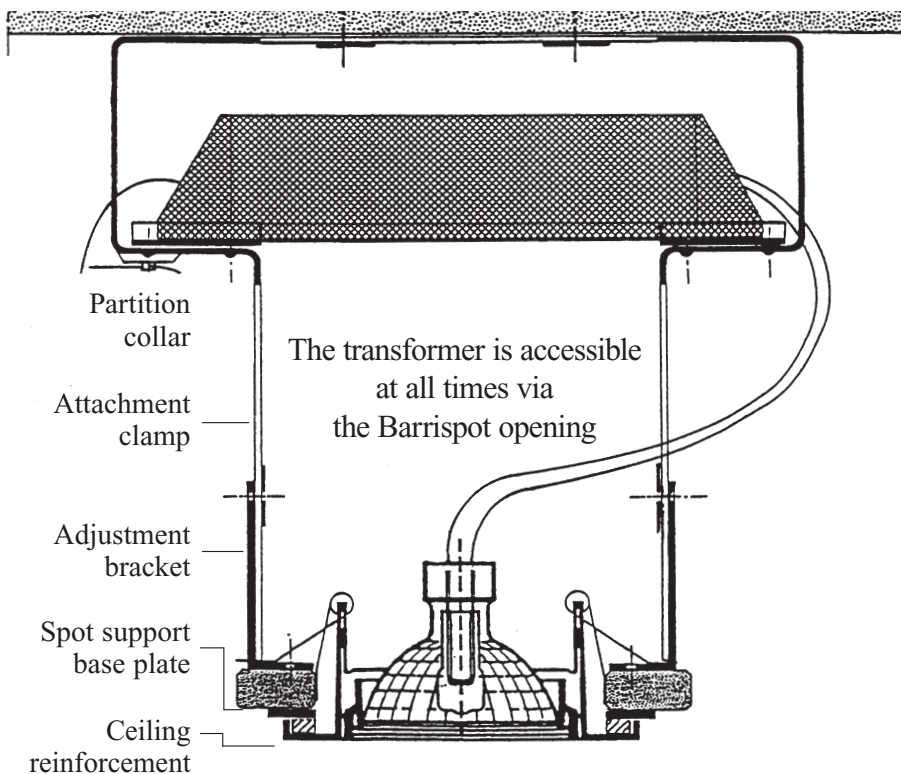

Technical characteristics:

- 12 Volt transformer with thermal protection
- Class II
- Adjustable 12 Volt halogen spot, outer diameter 110 mm – inner diameter 90 mm, 50 mm diameter glass bulb, spot colours: silver chrome, gold chrome, white, black
- Transformer and spot can be connected to 220 V

In the event of power surges, the transformer stops immediately.

BARRISPOTS AT ANY PLENUM HEIGHT

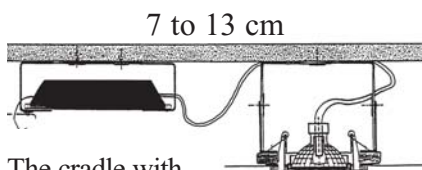

The cradle with its transformer are placed next to the Barrispot in the desired direction and connected to each other.

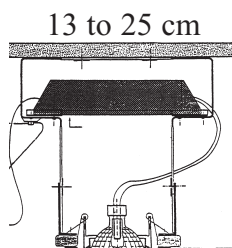

The Barrispot is installed directly onto the existing ceiling.

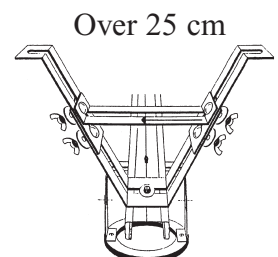
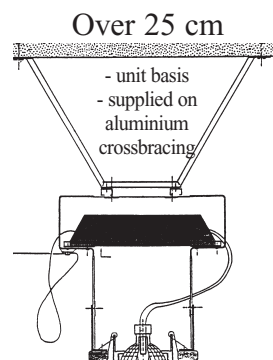

For several Barrispots on zinc-coated rails and crossbracing.

BARRISOL LIGHT BOXES
(NOT AVAILABLE IN CANADA OR THE USA)

READY TO INSERT INTO BARRISOL CLASSIC AND BARRISOL STAR CEILINGS

BARRISOL UNO LIGHT
with class C optical unit

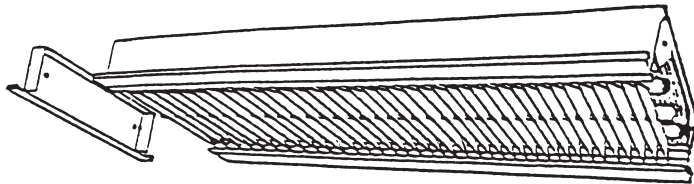

- Barrilec box made of white steel plate with built-in Barrisol Classic tracks for direct interlocking of Barrisol ceilings
- Satin gloss aluminium parabolic reflectors brightened glossy with high reflection power and low brightness.

Polar diagram light intensity distribution

Standardised output
of 0.6 l light

DIN 5040	A60
UTE C 71-121	0.61 + 0.00 T
NBN L 14-002	BZ 2
CIBSE TM5	BZ 1
CIE Flux Code	69 93 99 100 61

C 0 - C 180
C 90 - C 270

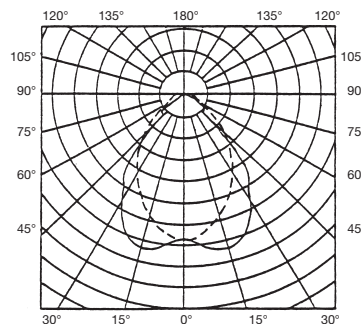

BARRISOL DUO LIGHT BLOCK
with class C optical unit

Box made of white steel plate with built-in Barrisol Classic tracks

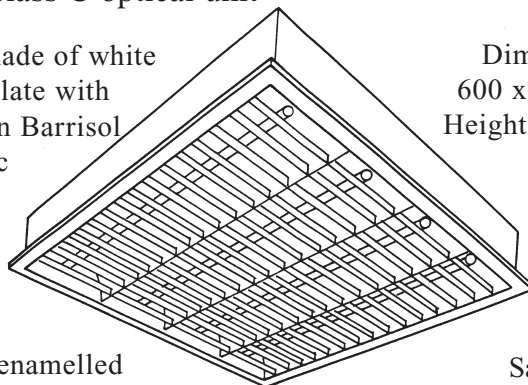

Dimensions:
600 x 600 mm
Height 100 mm

Satin white enamelled transverse plates

Satin gloss aluminium reflectors

The reflection power of the optical unit is reinforced with additional parabolic reflectors above the neon tubes.

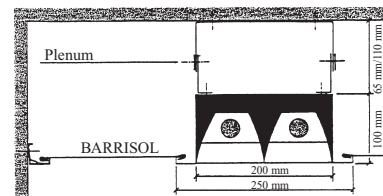

Installation (sectional view)

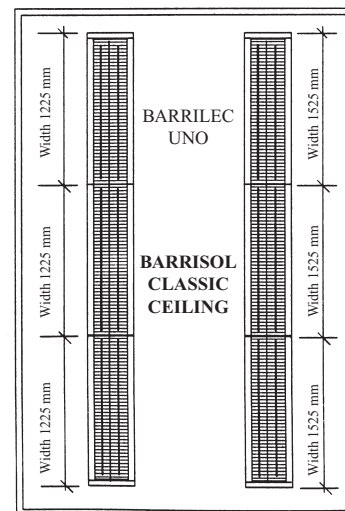

Stretch ceiling interlocked on the periphery of the Barrilec Uno units and the room.

Technical characteristics
of Barrilec Duo lights

wiring: 220 Volts with starter
ballast: 230 Volts - 50 Hz compensated capacitors: 250 Volts 9 µFarad
tubes: 4 x 18 Watts, 26 mm diameter

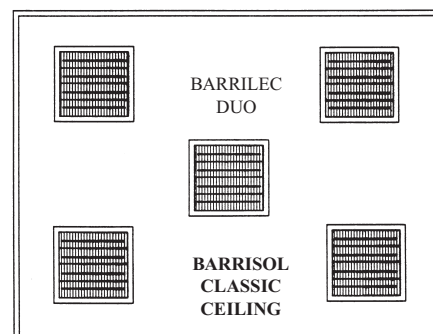

Stretch ceiling interlocked on the periphery of the Barrilec Duo units and the room.

LIGHTS AND LIGHT SUPPORTS

SUSPENDED, EMBEDDED, INSERTED IN BARRISOL UNIVERSE STRETCH CEILINGS

SUSPENDED LIGHT

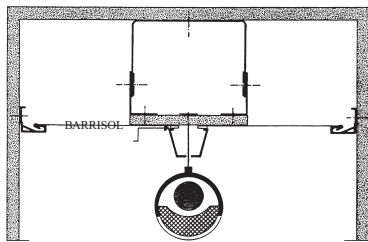

- adjustable support in plenum
- ceiling passage reinforcement

EMBEDDED LIGHT

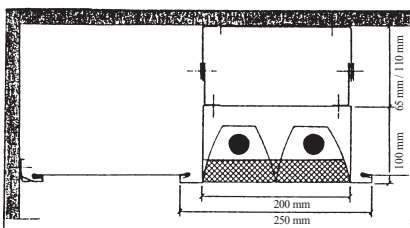

- light suspended by adjustable support
- stretch ceiling in tracks built into light

REMOVABLE LIGHT SUPPORT DEVICE



- track fixed onto aluminium rail
- T-connection used to install light

LIGHT SUPPORT SEPARATOR

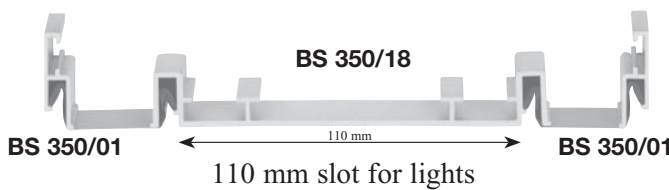

SPOT SUPPORT SEPARATOR

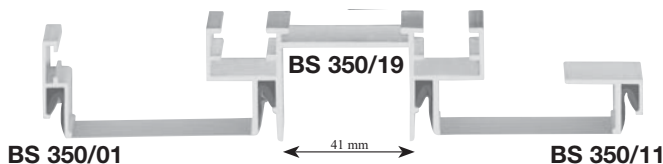

The rail may be machined to install small spots.

OPTICAL FIBRE INSTALLATION

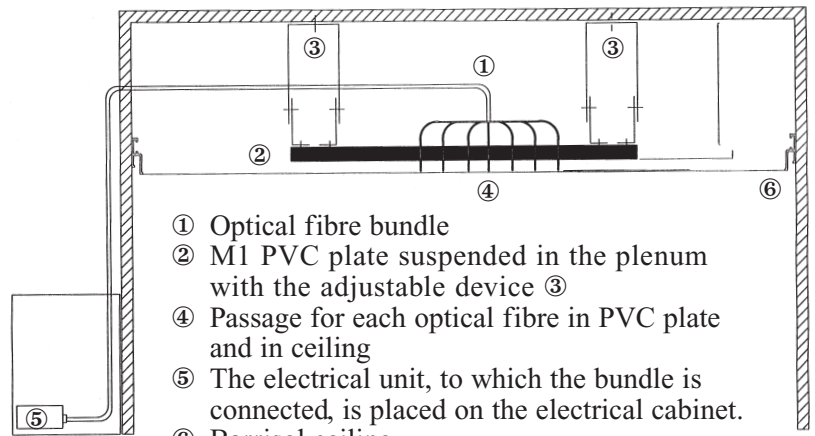

- ① Optical fibre bundle
- ② M1 PVC plate suspended in the plenum with the adjustable device ③
- ④ Passage for each optical fibre in PVC plate and in ceiling
- ⑤ The electrical unit, to which the bundle is connected, is placed on the electrical cabinet.
- ⑥ Barrisol ceiling

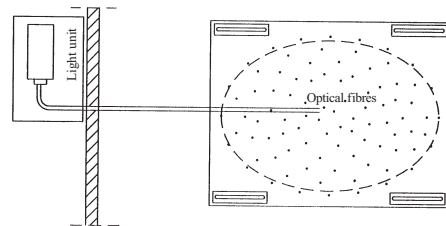

Optical fibres (top view)

INSET BARRISOL 26 mm DIAMETER MINI-SPOTS

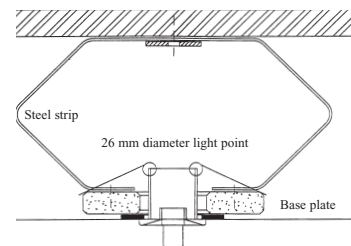

- mini-spot and its attachment and adjustment system in Barrisol ceiling
- 1 transformer for 10 mini-spots

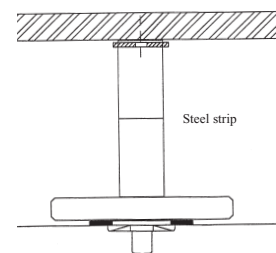

- 26 mm diameter, 5 W light point
- reinforced passage in stretch ceiling

3D LIGHTING

BARRISOL STAR FABRIC LININGS COVER THE INDIRECT MOUNTED LIGHTS.

WOODEN FRAMEWORK MOUNTED LIGHTS ON ROOM PERIPHERY

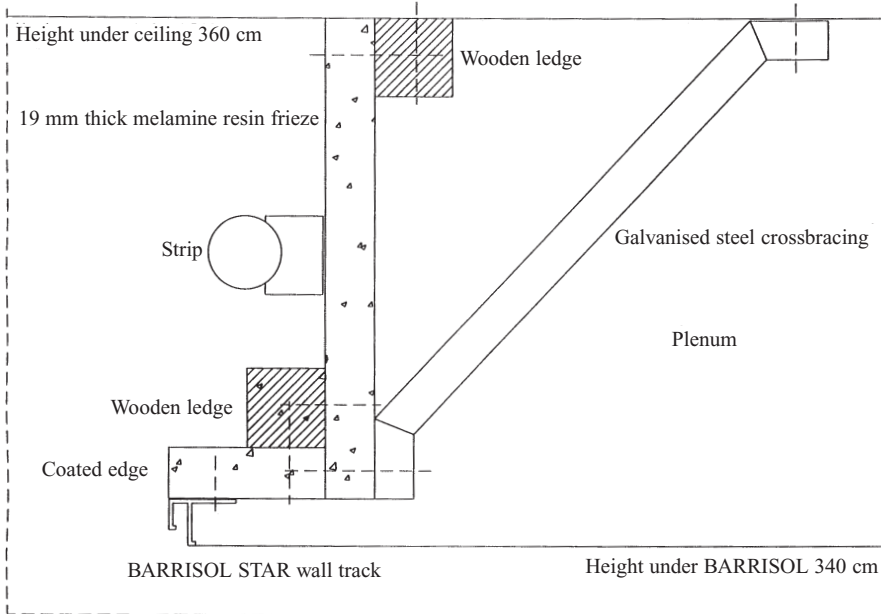

The Barrisol Star wall lining is stretched in the Barrisol Star track on the underside of the foot light, up to its end. The light is visible on the periphery, above the Barrisol Star ceiling.

CENTRAL MOUNTED LIGHT WITH SYMA M0 ALUMINIUM FRAMEWORK

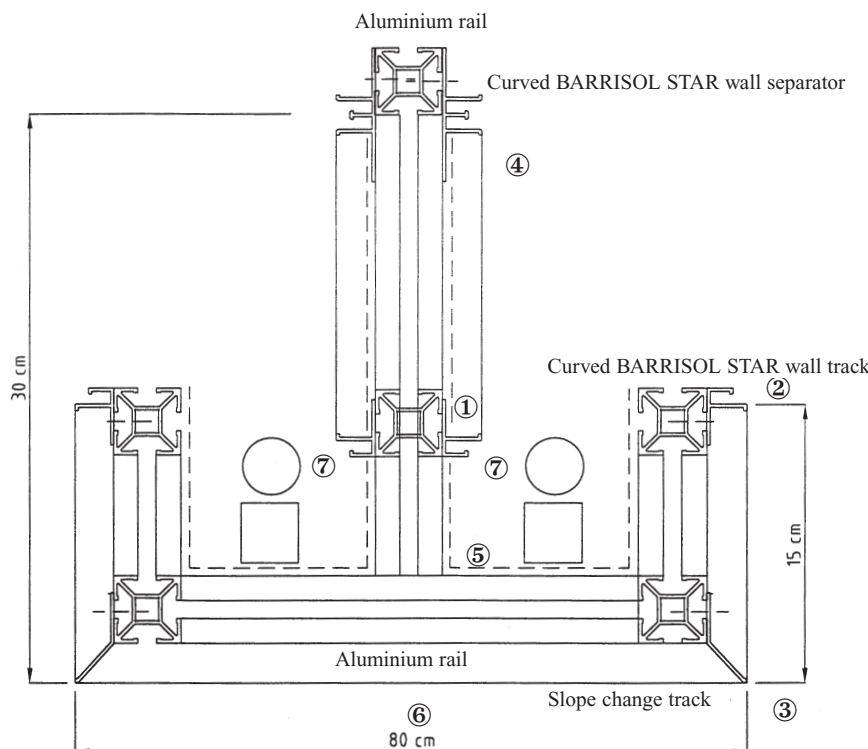

The Syma aluminium rails ① form the framework, combined with curved Barrisol Star wall tracks ②, with Barrisol slope changing rails ③, with the curved-Barrisol Star separator ④. A screen fabric is stretched inside the framework ⑤. The outside is equipped with Barrisol Star wall lining ⑥. The neon strips ⑦ are installed inside the framework.



SIMULATED GLASS ROOF

DETAILS OF "GLASS ROOF"

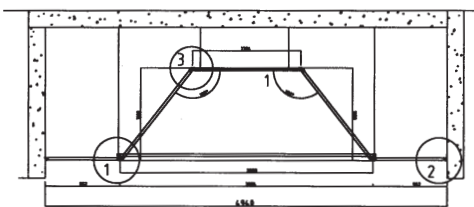

Longitudinal sectional view

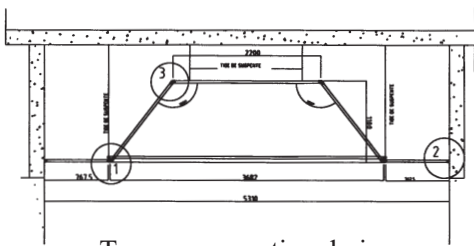

Transverse sectional view

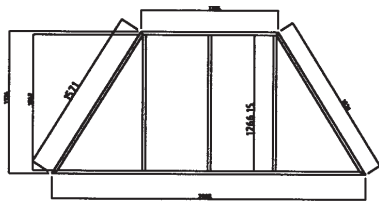

Transverse detailed view of frame

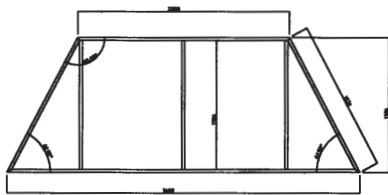

Longitudinal detailed view of frame

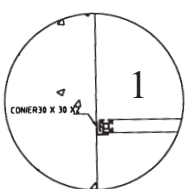

Outer periphery

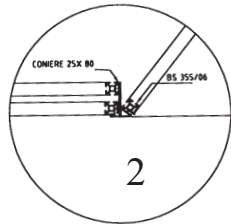

Inside of "glass roof"

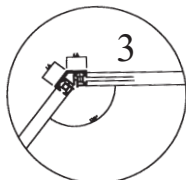

Frame joins

GLASS ROOF CREATION WITH TRANSLUCENT BARRISOL STAR LIT BY A HIGHER LIGHT SOURCE

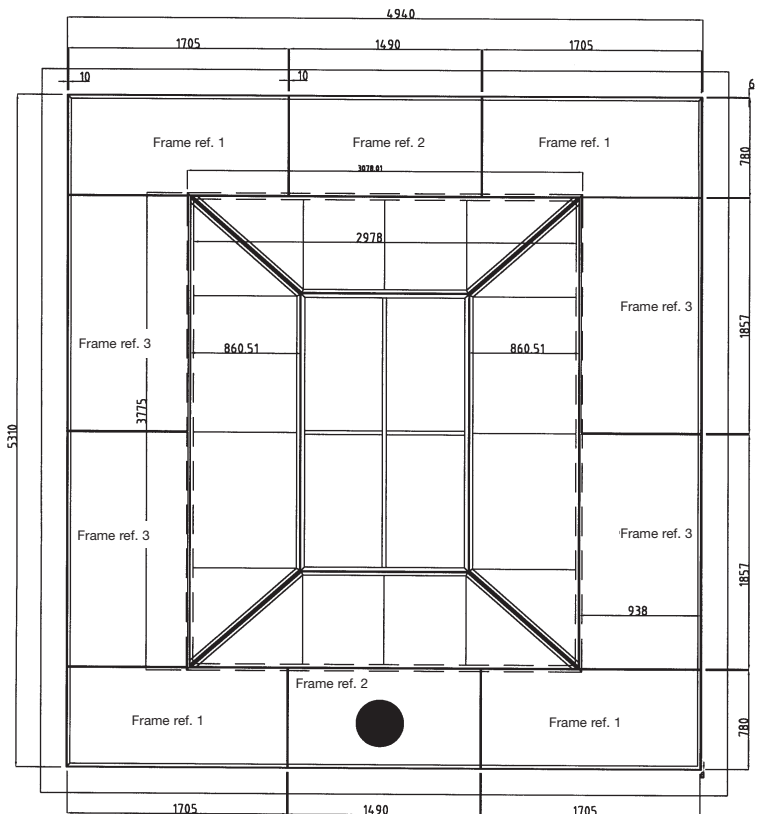

- Installation of a Syma rail aluminium frame enables the volume effects, with built-in Barrisol Star interlocking system.
- Translucent Barrisol Star stretch ceilings inserted into the Syma frame.
- Crossed stiffeners at the rear of the translucent Barrisol Star to simulate the glass roof.
- Lighting installed above the "glass roof".

Architect: Michel Laurent

- GLOBE -

BARRISOL FOR ALL LIGHTING TYPES

**BARRISOL TECHNIQUES AND ACCESSORIES MAKE IT POSSIBLE
TO INSTALL AND ENSURE THE STABILITY OF ALL LIGHTING TYPES
IN BARRISOL UNIVERSE STRETCH CEILINGS**



BARRISOL UNIVERSE STRETCH CEILINGS INCORPORATE:

Lights and suspensions

Mounted spots

Inset electrical rails

Optical fibres

Suspended lights

Suspended flood lights

Spots complying with Barrisol standards

Suspended electrical rails

Suspended light structures

Inset lights

Light strips

Iodide spots, etc.



EXAMPLE OF PROJECTS



Pietro GIORDANO, Architect



Architect office RTKL

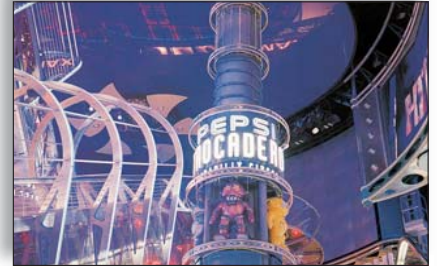

Christopher JONES, RTKL



Dalena CERMAKOVA, Architect



Daniel HULAK, Architect



Hubert PENICAUD, Architect



Creation : Angel MORETTA



Netanel BEN-IZCHAK, Architect

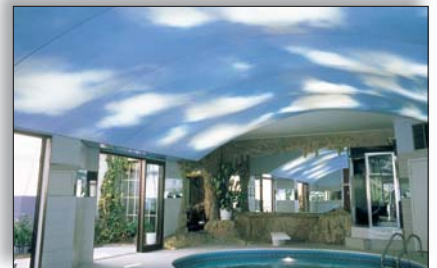

MATTIA Design



S. GODIN, MORENCY Group



Ferdi NIEDERSTEIN & Yves MEYER

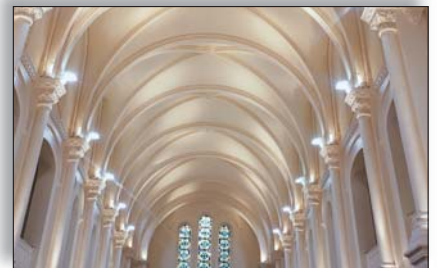

Yves DURAND, S.T.D.E. 2A

BARRISOL® *MICROACOUSTIC®*

BARRISOL® MICROACOUSTIC® is a special resonance absorber also called a microperforated sound absorber. From a physical point of view, this type of absorber acts in a way which is both fascinating and effective: the microperforations convert sound energy into heat energy. The viscous friction of air in the holes is reinforced by resonance in the volume of air trapped between the material and the rear wall, which generates the impressive acoustic properties of this microperforated sound absorber.

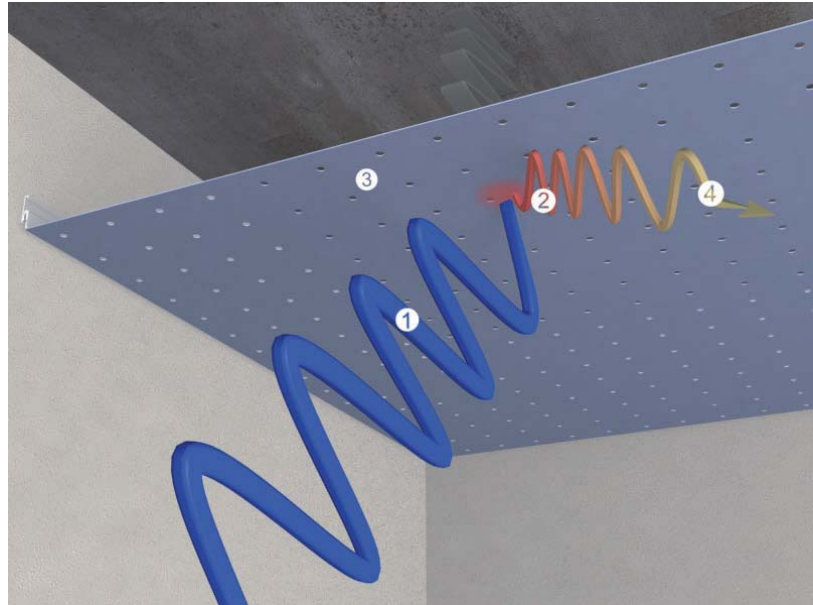

- ① Initial sound
- ② Sound transformation in thermic energy
- ③ Barrisol Acoustics
- ④ Reduced sound

Many factors affect room acoustics. Apart from the shape of the room, it is essentially the characteristics of furnishings such as the materials used for the floor, walls and ceiling which determine how sound is propagated in the room. The dimensions and positions of sound-absorbing areas and also those which reflect sound are essential factors which determine whether room acoustics are "good" or "bad". "Good" acoustics means that the acoustic conditions are appropriate for the use to which the room is put. It is clear that a concert hall needs a different set of acoustics from those of a church or a large office.

Theoretically, every room can be structured to provide optimal acoustics for its use. The shape and dimensions of the room are as important when designing acoustics, as is the choice and positioning of materials for the interior and other types of equipment. In practice, however, there is often only a single solution to regulate room acoustics, which is to change the material used for the ceiling and walls. Sound absorbing materials such as BARRISOL® MICROACOUSTIC® or other BARRISOL acoustic products are used for targeted adjustment of sound absorption and the room reverberation time.



BARRISOL UNPERFORATED AND BARRISOL MICROACOUSTIC® +ACOUSTIC TEST RESULTS



Architect : Netanel BEN IZCHAK

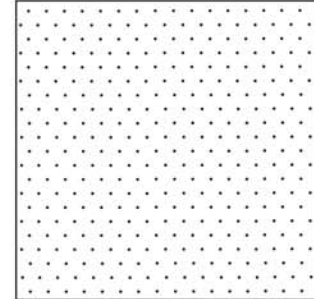

Quantity of holes: 250 000 holes/sqm
Diameter of a hole : ≈ 0,2 mm
Perforation rate: ≈ 0,8 %
Thickness: ≈ 0,17 mm
Reference : 036 + ref. of the colour

- **BARRISOL unperforated sheet without insulation and BARRISOL-MICROACOUSTIC® without insulation**

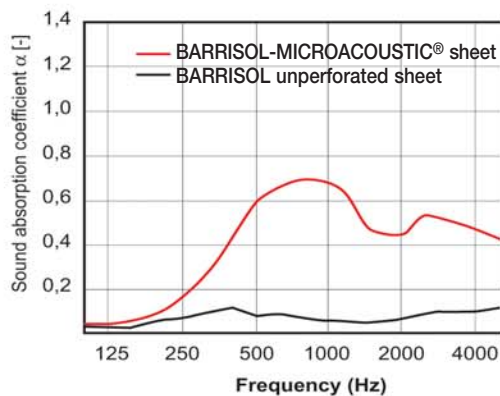

Acoustic absorption rating

Sound Absorption Average according to ASTM C 423-01	SAA = 0,07
Noise Reduction Coefficient according to ASTM C 423-1	NRC = 0,05
Weighted sound absorption coeff. according to EN ISO 11654	α_w = 0,10
Sound Absorber class according to EN ISO 11654	not classified
Sound Absorption Average according to ASTM C 423-01	SAA = 0,45
Noise Reduction Coefficient according to ASTM C 423-01	NRC = 0,45
Weighted sound absorption coeff. according to EN ISO 11654	α_w = 0,45
Sound absorber class according to EN ISO 11654	Class D

- **BARRISOL unperforated sheet with insulation and BARRISOL-MICROACOUSTIC® with insulation**

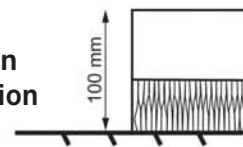
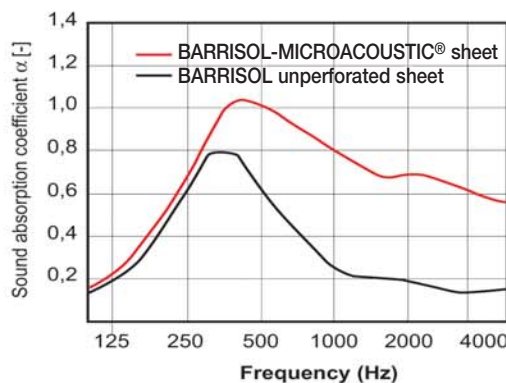

Rock wool :
Weight : 0,52 kg/sqm
 $r = 7,4$ kNs/m² on floor

BARRISOL sheet non perforated
BARRISOL-MICROACOUSTIC® sheet

Acoustic absorption rating

Sound Absorption Average according to ASTM C 423-01	SAA = 0,42
Noise Reduction Coefficient according to ASTM C 423-1	NRC = 0,40
Weighted sound absorption coeff. according to EN ISO 11654	α_w = 0,25
Sound Absorber class according to EN ISO 11654	Class E
Sound Absorption Average according to ASTM C 423-01	SAA = 0,78
Noise Reduction Coefficient according to ASTM C 423-01	NRC = 0,80
Weighted sound absorption coeff. according to EN ISO 11654	α_w = 0,75
Sound Absorber class according to DIN EN 11654	Class C

Example of installation



Architect : Ms REHDER

In its original condition, the "Herrensaal" in the nave of St. Petri 's Church composed mainly of resounding surfaces such as plaster, glass and wood. Experience has shown that an absorbing effect can only be expected in the deep frequency range with glass façades and wooden surfaces. The aim of the acoustic concept was thus a significant reduction in the reverberation time as well as a smoothing-out of its frequency dependence. The particular advantage of Barrisol® - Microacoustic® sheeting lies in the fact that the degree of absorption can be adjusted precisely to the requirements of the respective room through the choice of distance between the sheeting and the rear wall. In this project, this gap was chosen to be 70 mm. So three panels of 12sqm have been used.

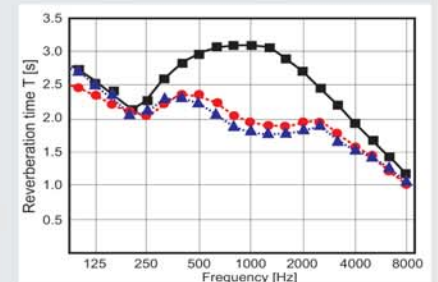

■ Measurement before renovation
▲ Acoustic design
● Measurement after renovation

BARRISOL UNPERFORATED AND BARRISOL PERFORATED +ACOUSTIC TEST RESULTS

BARRISOL matt sheet unperforated with and without insulation

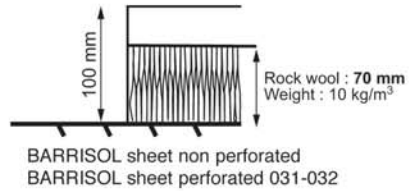
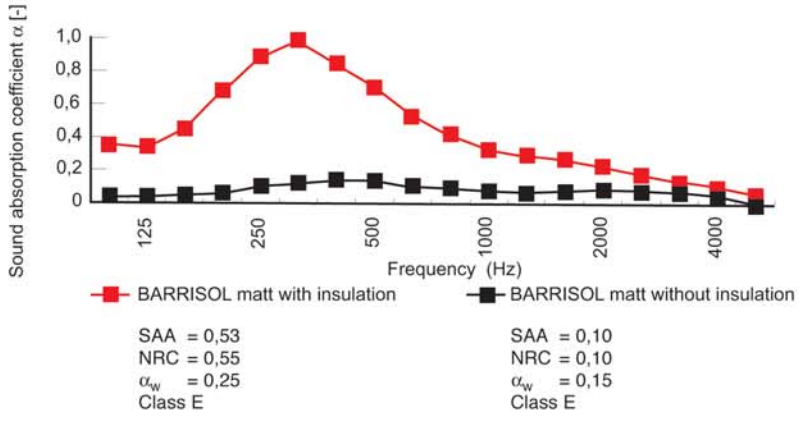

BARRISOL perforated sheet 031 with and without insulation

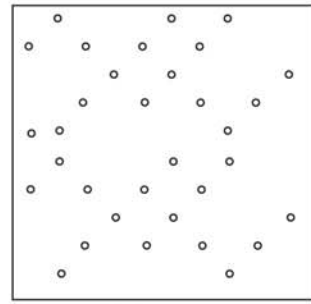
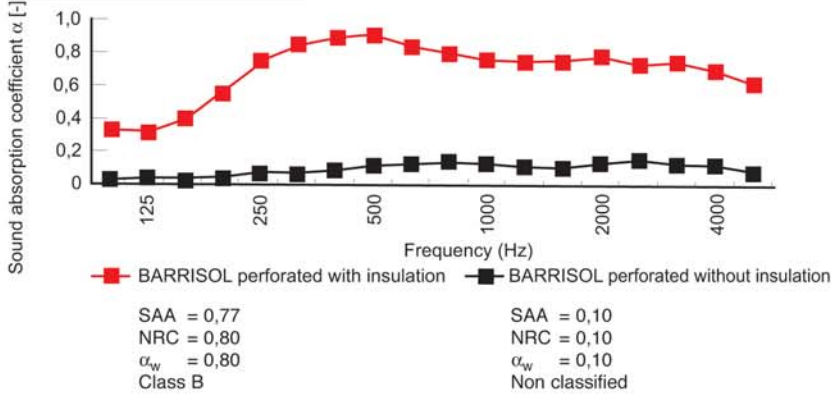

Quantity of holes : 10 000/sqm
Diameter of a hole : ≈ 1 mm
Perforation rate : ≈ 4 %
Thickness : ≈ 0,17 mm
Reference : 031 + ref. of the colour

BARRISOL perforated sheet 032 with and without insulation

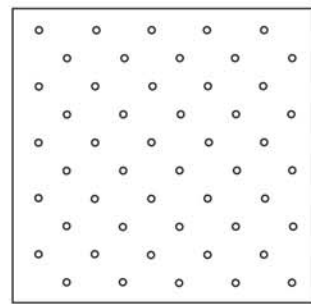
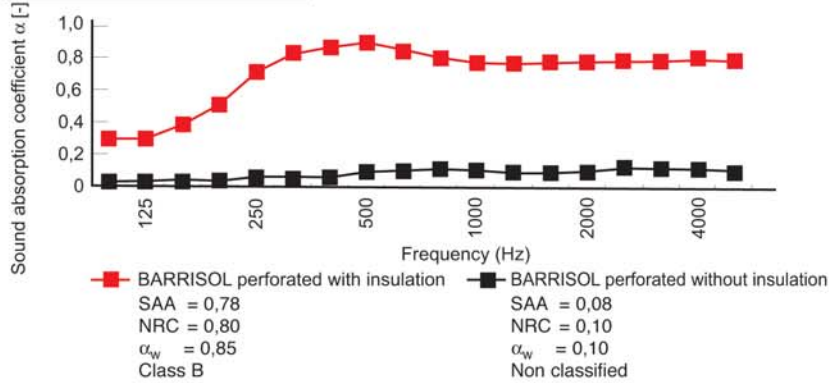

Quantity of holes : 50 000/sqm
Diameter of a hole : ≈ 1 mm
Perforation rate : ≈ 20 %
Thickness : ≈ 0,17 mm
Reference : 032 + ref. of the colour



BARRISOL MINIPERF +ACOUSTIC TEST RESULTS



Architect : Aydin SESIGUR

• BARRISOL MINIPERF sheet with and without insulation

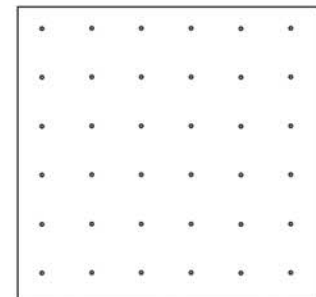
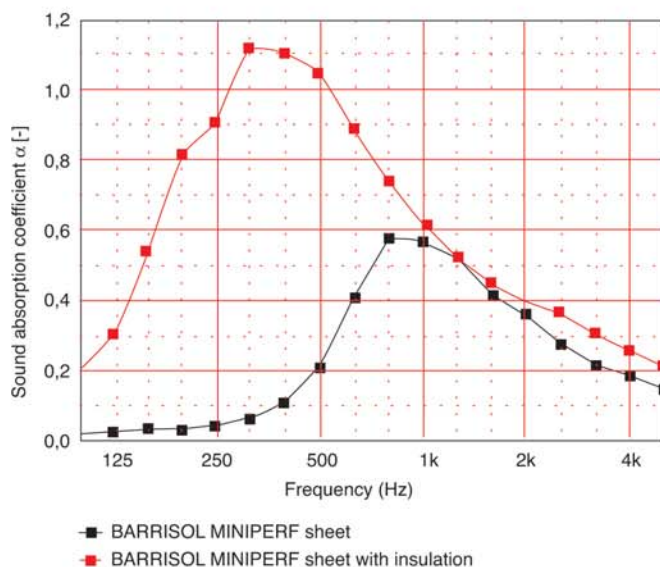

Quantity of holes 4 000 hole/sqm
 Diameter of a hole : ≈ 0,5 mm
 Perforation rate : ≈ 0,5 %
 Thickness - 0,30 mm
 Reference 037 + ref. of the colour

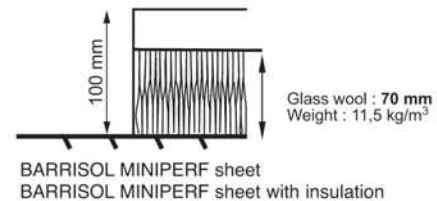

Acoustic absorption rating

Sound Absorption Average according to ASTM C 423-01 SAA = 0,30
 Noise Reduction Coefficient according to ASTM C 423-01 NRC = 0,30
 Weighted sound absorption coeff. according to DIN EN ISO 11654 α_w = 0,30
 Sound absorber class according to DIN EN ISO 11654 Class D

Sound Absorption Average according to ASTM C 423-01 SAA = 0,75
 Noise Reduction Coefficient according to ASTM C 423-01 NRC = 0,75
 Weighted sound absorption coeff. according to EN ISO 11654 α_w = 0,40
 Sound absorber class according to EN ISO 11654 Class D

Example of installation



Architects : KEREZ
MORGER & DEGELO

The custom made solutions of BARRISOL lumiere ceilings offer a great aesthetic value and an optimal translucency. The ceilings, formulated with an intelligent integrated technology to spread the light, ensure that the art exhibits at the Art Museum of Vaduz in Lichtenstein are shown to their best advantage. Under a glass roof equipped with a sophisticated lighting technology, the BARRISOL LUMIERE ceiling reveals all of its qualities, whether acoustic or aesthetic.

In fact, another advantage of the BARRISOL LUMIERE ceiling is the acoustic properties which improve in larger rooms, through a special procedure of micro-perforation, the rooms with high ceilings, such as the rooms of the Art Museum in Vaduz, enjoy particularly good acoustics.

PART 1- GENERAL**1.01 RELATED DOCUMENTS**

- A. Drawings and general provisions of the Construction Contract, including General and Supplementary Conditions and Division 1 Specification Sections, apply to work of this Section.

1.02 SUMMARY

- A. This Section includes stretched membrane ceiling systems complete with accessories for interior installations.
- B. Related Sections:
 - 1. Division 1 – Section Alternates
 - 2. Division 16- Section Electrical for additional or larger size wires, as required to properly support lighting fixtures to be furnished and installed by the Electrical Contractor.

1.03 REFERENCE STANDARDS

- A. Requirements, abbreviations and acronyms for reference standards are defined in Section 01095.
- B. Fire Rating: BARRISOL stretched ceiling shall have a fire hazard of Class I in the USA within the requirements of the ASTM E84 Flame Spread Test.
- C. Other Testing: BARRISOL stretched ceiling shall successfully meet criteria for: UBC 17-5 Room Fire Test Standard, N.Y.S. Pittsburgh Protocol Toxicity Test City of New York Building Department.
- D. Stretched ceiling system must be UL approved.

1.04 QUALITY ASSURANCE

- A. The work of this section shall be performed by a company which specializes in the type of stretched ceiling system required by this project, with a minimum of 5 years documented successful experience and shall be performed by skilled workmen thoroughly trained in the necessary craft. Work shall be performed in compliance with Owner's insurance underwriters' requirements and UL Approvals and Testing for materials, assemblies and procedures.
- B. The membrane shall be stretched over the subsurface and hooked into the BARRISOL rails without glue or clips.
- C. The stretch ceiling membrane shall be removable by hand and approved tools for visible inspection, to provide access above the stretched membrane, and to provide for subsequent re-installation.
- D. The membrane shall not be less than 17/100 mm thick and shall not have a weight of more than 35g per square foot for all finishes except Brushed Suede.
- E. Brushed Suede membrane shall not be less than 35/100 mm thick and shall not have a weight of more than 35g per square foot.
- F. The width of sheeting between two factory welds shall not be less than 5'6".
- G. All membranes / sheets (except brushed Suede) shall be washable.



1.05 SUBMITTALS

- A. Product Data: Shall be clearly marked to indicate all technical information which specifies full compliance with requirements of this Section, Contract Documents, and the manufacturers' published installation recommendations, including but not limited to the following: samples and printed materials.
- B. Dealer Certification: Submit in writing the manufacturers' certification.
- C. Warranty: Submit manufacturers' limited warranty against defects in product, harpoon welds, sheet welds and colorfastness for a period of two years and workmanship for a period of ten years.
- D. Samples for Initial Selection Purpose: Submit samples of all standard colors and finishes for membranes and rails.
- E. Samples for Verification Purpose: Submit 6" square samples of each type and color of membrane and rails specified.
- F. Certified Test Reports: Submit test data from an independent testing agency, acceptable to authorities having jurisdiction, evidencing that ceiling assembly comply with requirements indicated for fire performance characteristics.

1.06 PROJECT CONDITIONS

- A. Do not begin installation until spaces to receive stretched ceilings have been enclosed, sufficient heat is provided, dust generating activities have terminated, and overhead mechanical and electrical work is completed, tested and approved.
- B. Permit wet work to dry prior to commencement of installation.
- C. Maintain uniform temperatures and humidity prior to, during and after installation.
- D. The ceiling cavity must be airtight.
- E. If a ventilation system is used, air intakes and outlets must have the right dimensions to be correctly balanced.

1.07 COORDINATION

- A. Coordinate layout and installation of ceiling system with other construction that penetrates the ceiling or is supported by them, including light fixtures, HVAC, fire suppression system, and partition assemblies.

1.08 STORAGE AND HANDLING

- A. Store all materials off the ground and protected from dirt and dust of construction operations.
- B. Materials are to be acclimated to installation conditions for 48 hours prior to installations.
- C. Handle all materials in a manner that will protect them from damage.

PART 2- PRODUCTS

2.01 ACCEPTABLE MANUFACTURERS

- A. The BARRISOL Stretch Ceiling as manufactured by BARRISOL Normalu S.A., 68680 Kembs, France (or manufactured under license). For the authorized licensed dealer in your area contact:

PRODUCT OF BARRISOL-NORMALU S.A.S. - 68680 KEMBS - FRANCE

Tél. : +33 (0)3 89 83 20 20 - Fax : +33 (0)3 89 48 43 44

E-mail : mail@barrisol.com

www.barrisol.com

2.02 COMPONENTS

- A. Stretch PVC (polyvinyl chloride base, guaranteed cadmium free) membrane-ceiling sheet: A ceiling membrane will be custom produced according to exact field measurements. The membrane will be connected together by factory welds to achieve the appropriate size. The Architect to select one of the following:
1. Finishes:
Matt, Satin, Lacquer, Translucent, Metallic, Brushed Suede, Perforated finish (1 mm available in all finishes, 4 mm available in matt and lacquer finishes, and 10 mm available in special matt finish 36/100 mm only). Antibacterial (available in white matt except by special order), Special Anti-static sheet (available in white lacquer except by special order).
- B. Harpoon: A semi rigid PVC harpoon (depending on rail type selected) is welded at the factory onto the perimeter of the ceiling membrane. Specify harpoon to be white or black.
- C. Seams / Welds: the seams will be lapped and factory welded. The seam location to be specified by the architect.
- D. Rails: Specify one of the following :
1. BARRISOL visible rails, PVC or Aluminium. Note PVC invisible rails do not meet the intent of this specification.
 2. BARRISOL STAR concealed rails, Aluminium.
- E. Rings: Reinforcement rings in Class A PVC available in the shape and size to fit light fixtures, sprinkler heads, HVAC, smoke detectors, etc.
- F. Acoustical Materials: Can be installed above the BARRISOL ceiling but not on it. This acoustical material must meet the requirements of the acoustical specialist and comply with the requirements of the Contract Documents.
- G. Acoustical BARRISOL: BARRISOL ceiling can be acoustical in its microperforation version with 20000 holes /sqft. / Test available on request).



PART 3- EXECUTION

3.01 SURVEY

- A. Install BARRISOL Stretch Ceiling System in accordance with approved submittals, reflected ceiling plan in Architectural Drawings, manufacturer's published recommendations and Contract Documents.
- B. Examine the condition of the installation site and the conditions. Notify the Contractor or Architect in writing of any unsatisfactory conditions. Do not proceed with the work until such conditions have been corrected in a manner satisfactory to the BARRISOL installers.
- C. Survey the installation site for exact field measurements for custom production of the ceiling membrane. Take actual field measurements for each ceiling.
- D. Inspect each space which is to receive wall fixed mounted rails. The surface where the rails will be fixed must be smooth, flat, and finished prior to installation of the rails.
- E. The stretched ceiling should only be installed if the wet work is completed and dry, the space is enclosed weather tight and dustfree, all painting and wall covering is completed and dry, the work of other trades is completed included electrical work, sprinkler systems, HVAC, etc.....

K40 SUSPENDED CEILINGS BARRISOL – BARRISOL STAR

To be read with Preliminaries / General conditions

TYPE(S) OF CEILING

116 STRETCH CEILINGS

- Location: - Site as specified
- Setting Out: - As indicated on drawings
- Structural Soffit(s): - As indicated on drawings
- Type: - BARRISOL membrane sheet with supporting trims
- Manufacturer: - BARRISOL NORMALU SAS, Kembs, France
- Installer: - BARRISOL NORMALU SAS. - 68680 KEMBS - FRANCE
Tél. : +33 (0)3 89 83 20 20 - Fax : +33 (0)3 89 48 43 44
E-mail : mail@barrisol.com- www.barrisol.com
- Colour: - Specify from Barrisol colour card incl. ref. no.
- Finish: - Matt/Satin/Lacquer/Metallic/Translucent/Perforated/Suede
- Sheet: - Material to be confirmed as complying with BS476 parts 6&7 class "O", plus Part 12, BS2782 and Euro classification EN13501-1. Panel width before seams to be min. 1.62m all finishes, or 2.2m Matt White, or 2.0m Translucent installed as option. Matt or Satin finishes should be a smooth finish not textured or granulated
- Track (choice): - Star Track (semi concealed) Aluminium – B350/01, 350/11, B350/16 without cover bead OR Classic Track (exposed) PVC White – B301, B350/03
- Profile: - As indicated on drawings. Shapes and forms to be within manufacturers guidelines
- Support system: - Typical suspension for double rail using galvanized MF system or similar
- Service Fittings: - As indicated on drawings
- Accessories: - As indicated on drawings
- Vapour Barrier: - Sheet to comply with BS3177 vapour test

Revised: October 2002



K40 SUSPENDED CEILINGS
BARRISOL TREMPO

To be read with Preliminaries/ General conditions

TYPE(S) OF CEILING

116 STRETCH CEILINGS TREMPO

- Location: - Site as specified
- Setting Out: - As indicated on drawings
- Structural Soffit(s): - As indicated on drawings
- Type: - BARRISOL membrane sheet with supporting trims
- Manufacturer: - BARRISOL NORMALU SAS, Kembs, France
- Installer: - BARRISOL NORMALU SAS - 68680 KEMBS - FRANCE
Tél. : +33 (0)3 89 83 20 20 - Fax : +33 (0)3 89 48 43 44
E-mail : mail@barrisol.com- www.barrisol.com
- Colour: - Specify from Barrisol colour card incl. Ref. no.
- Finish: - Matt/Satin/Lacquer/Metallic/Translucent/Perforated/Suede
- Sheet: - Material to be confirmed as complying with BS476 parts 6&7 class "O", plus Part 12, BS2782 and Euro classification EN13501-1.
- Will be joined by lacing to the Barrisol Trempo track attached to the periphery of the walls, or partition walls in the case of large surfaces. A class "0" steel safety small chain will be attached every 3 metres.
- Large panels will be divided in width approximately every 6 metres to retain their even surface and joined with a special double track aluminium rail or invisible joint finish or with a lighting strip with built-in interlocking rails.
- Track (choice) : - Aluminium Track with perforation to allow the hook to be installed.
- Profile: - As indicated on drawings. Shapes and forms to be within manufacturers guidelines
- Support system: - Typical suspension for double rail using galvanized MF system or similar
- Service Fittings: - As indicated on drawings
- Accessories: - As indicated on drawings
- Vapour Barrier: - Sheet to comply with BS3177 vapour test

K40 SUSPENDED CEILINGS BARRISOL MICROPERF

To be read with Preliminaries/ General conditions

TYPE(S) OF CEILING

116 STRETCH CEILINGS MICROACOUSTIC (ACOUSTICS)

- Location: - Site as specified
- Setting Out: - As indicated on drawings
- Structural Soffit(s): - As indicated on drawings
- Type: - BARRISOL-MICROPERF membrane sheet with supporting trims
- Manufacturer: - BARRISOL NORMALU SAS, Kembs, France
- Installer: - BARRISOL NORMALU SAS - 68680 KEMBS - FRANCE
Tél. : +33 (0)3 89 83 20 20 - Fax : +33 (0)3 89 48 43 44
E-mail : mail@barrisol.com- www.barrisol.com
- Colour: - Specify from Barrisol colour card incl. Ref. no.
- Finish: - Matt/Satin/Lacquer/Metallic/Translucent/Perforated
- Sheet: - Material to be confirmed as complying with BS476 parts 6&7 class "O", plus Part 12, BS2782 and Euro classification EN13501- 1. Panel width before seams to be min. 1.62m all finishes. Matt or Satin finishes should be a smooth finish not textured or granulated. The material will be perforated with approximately 300.000 microholes/m² should be installed at the predetermined height to obtain the desired acoustics. The perforated sheet should have a $\alpha_s = 0.45$ and a NRC of 0.45 at a distance of 100mm.
- Track (choice): - Star Track (semi concealed) Aluminium – B 350/01, 350/11, B350/16 without cover bead OR Classic Track (exposed) PVC White-B301, B350/03
- Profile: - As indicated on drawings. Shapes and forms to be within manufacturers guidelines
- Support system: - Typical suspension for double rail using galvanized MF system or similar
- Service Fittings: - As indicated on drawings
- Accessories: - As indicated on drawings
- Vapour Barrier: - Sheet to comply with BS3177 vapour test

Revised: October 2002



B301/.

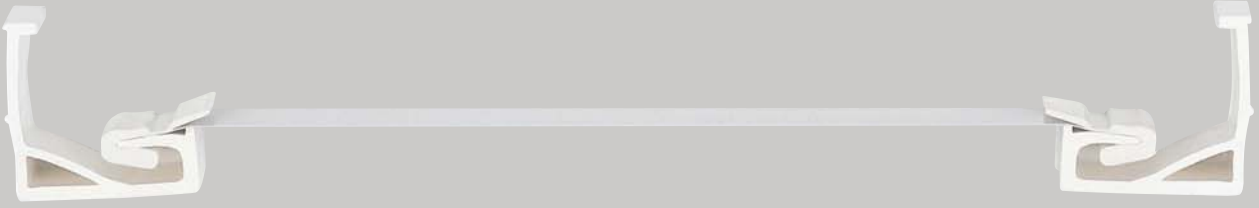

B301/.

B310/.



B310/.

B326/01



B326/01

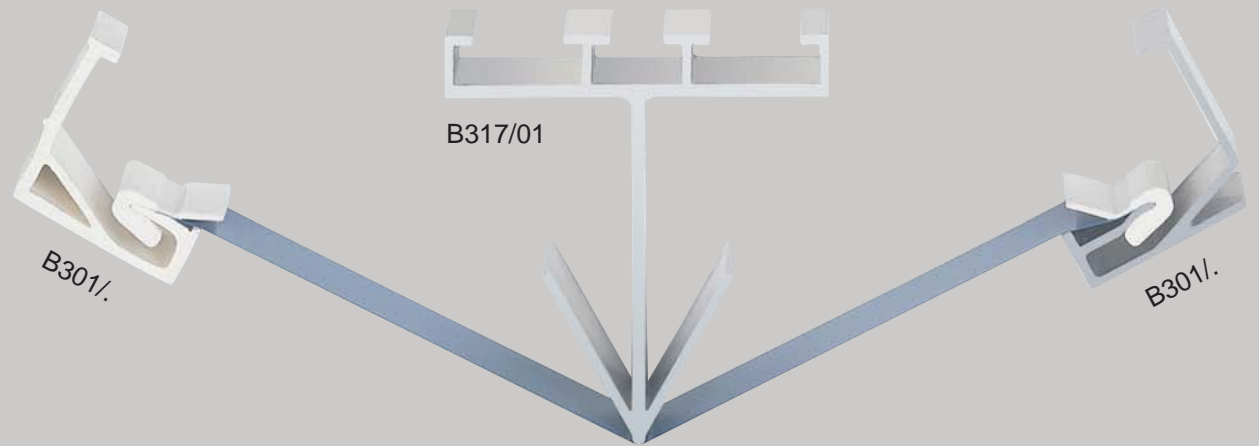

B317/01

B301/.

B301/.

B310/.

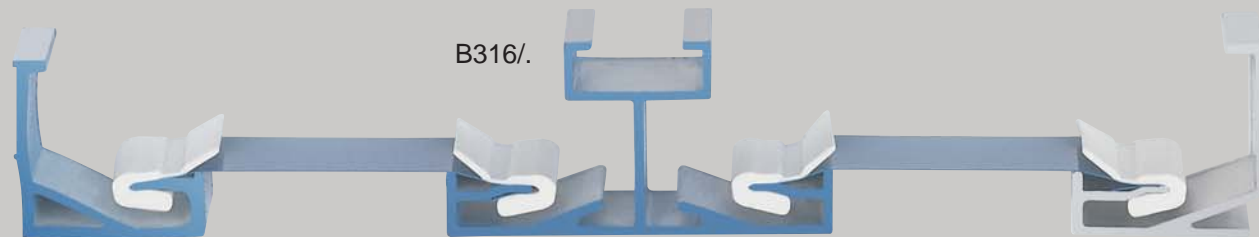

B316/.

B310/.

B318/01



B310/.

B310/.



B311



B311

B312



B312

B313

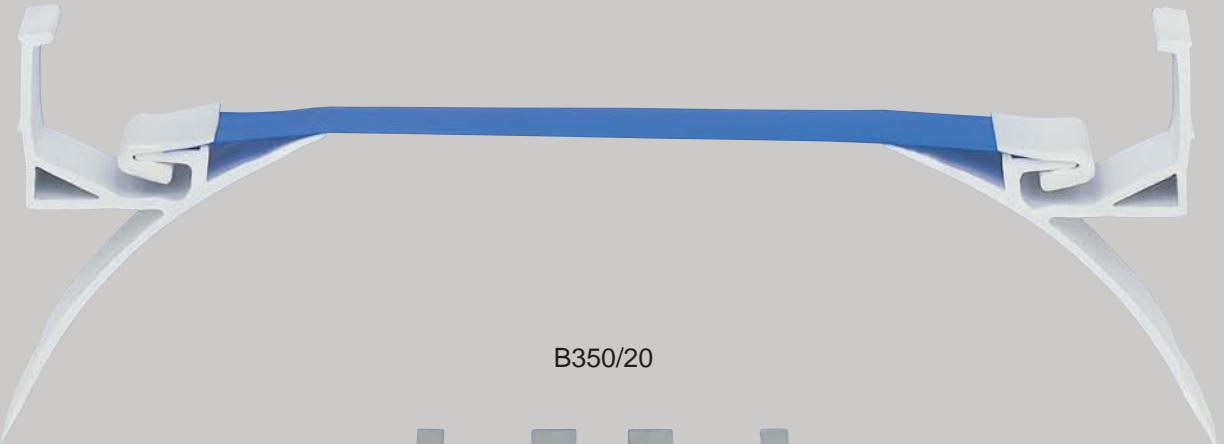

B313

B350/20



B312



B312

B318/01



B311



B311

B318/011



BARRISOL®

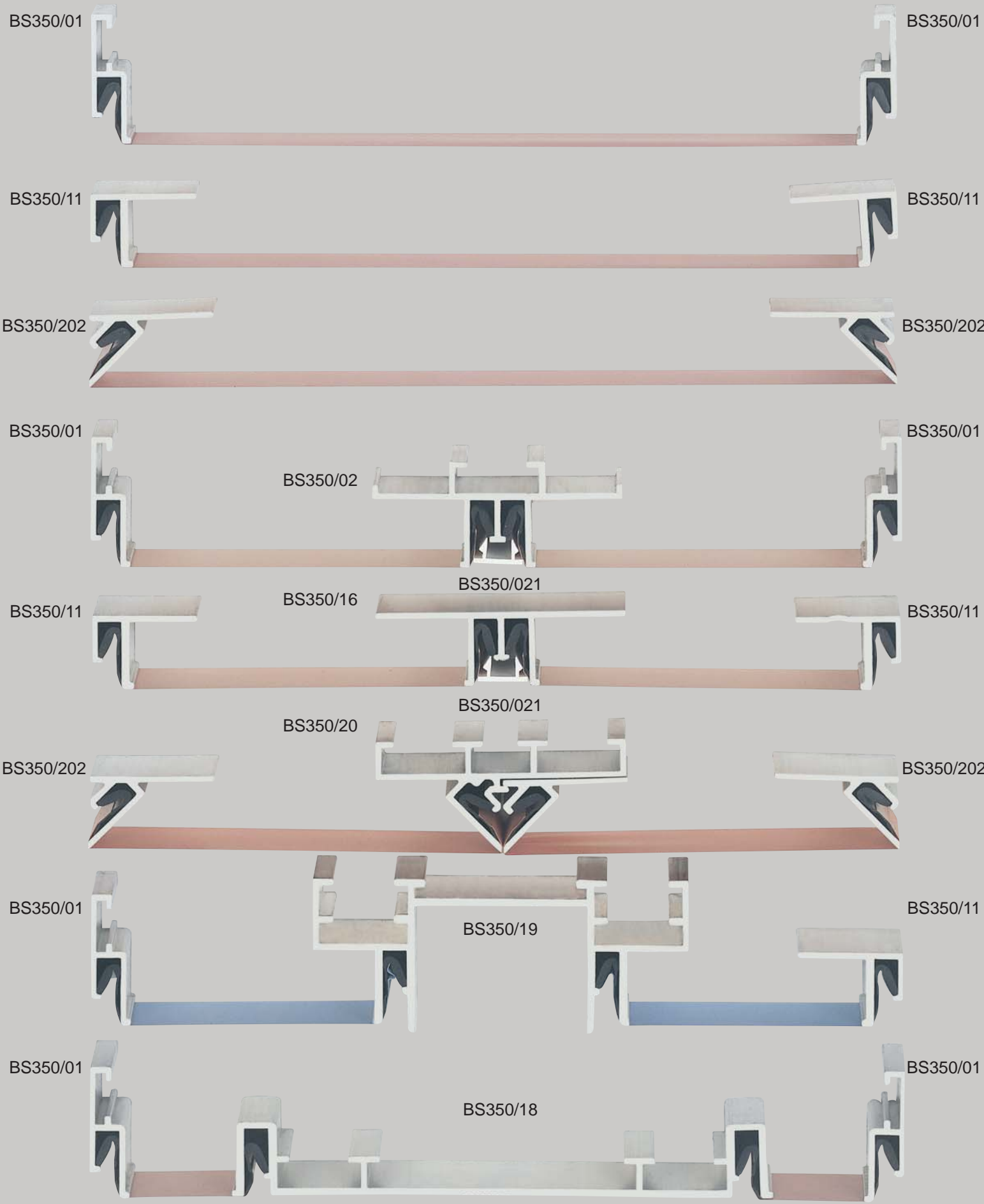

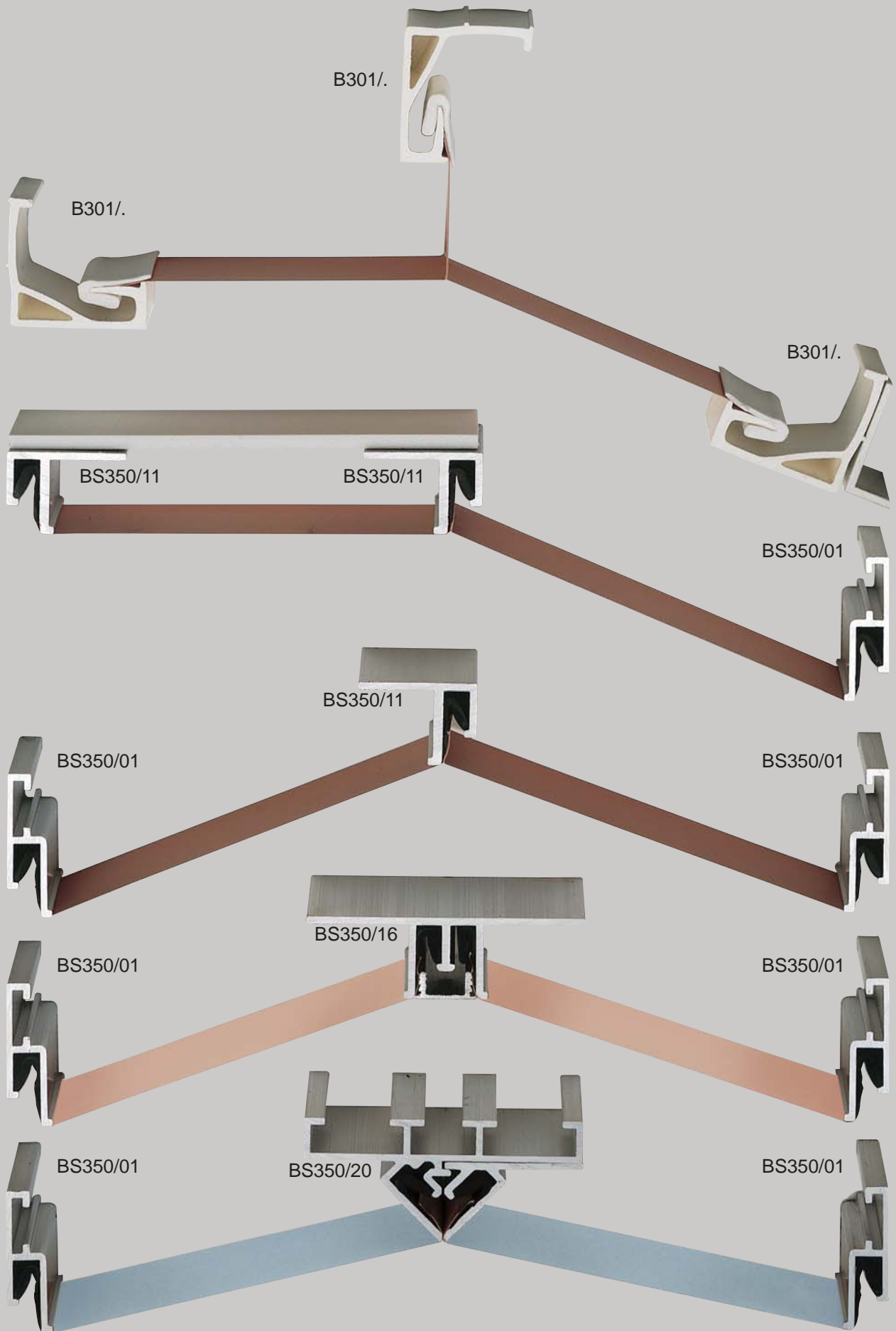



BS350/04



BS350/04

BS350/05

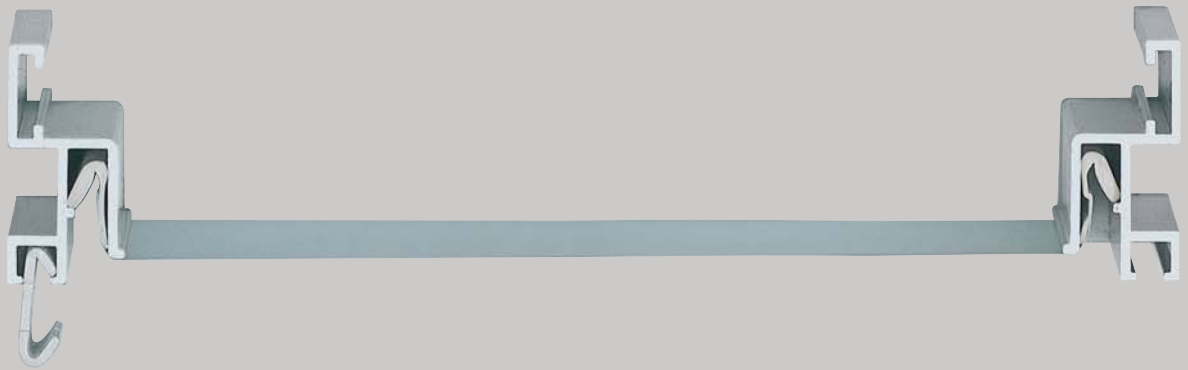

BS350/05

BS350/06



BS350/06

BS350/10

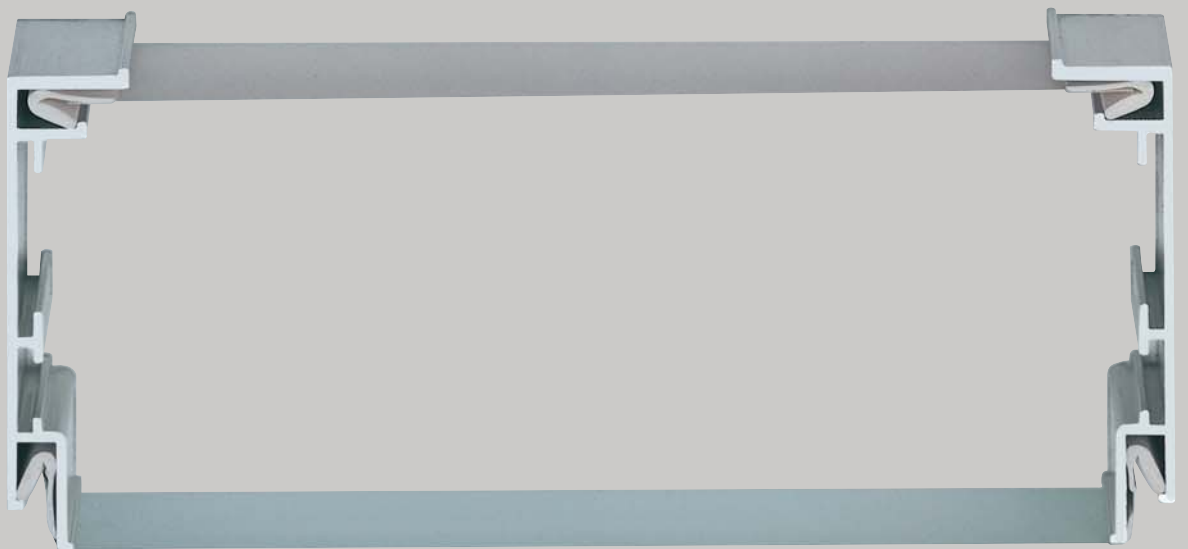

BS355/10

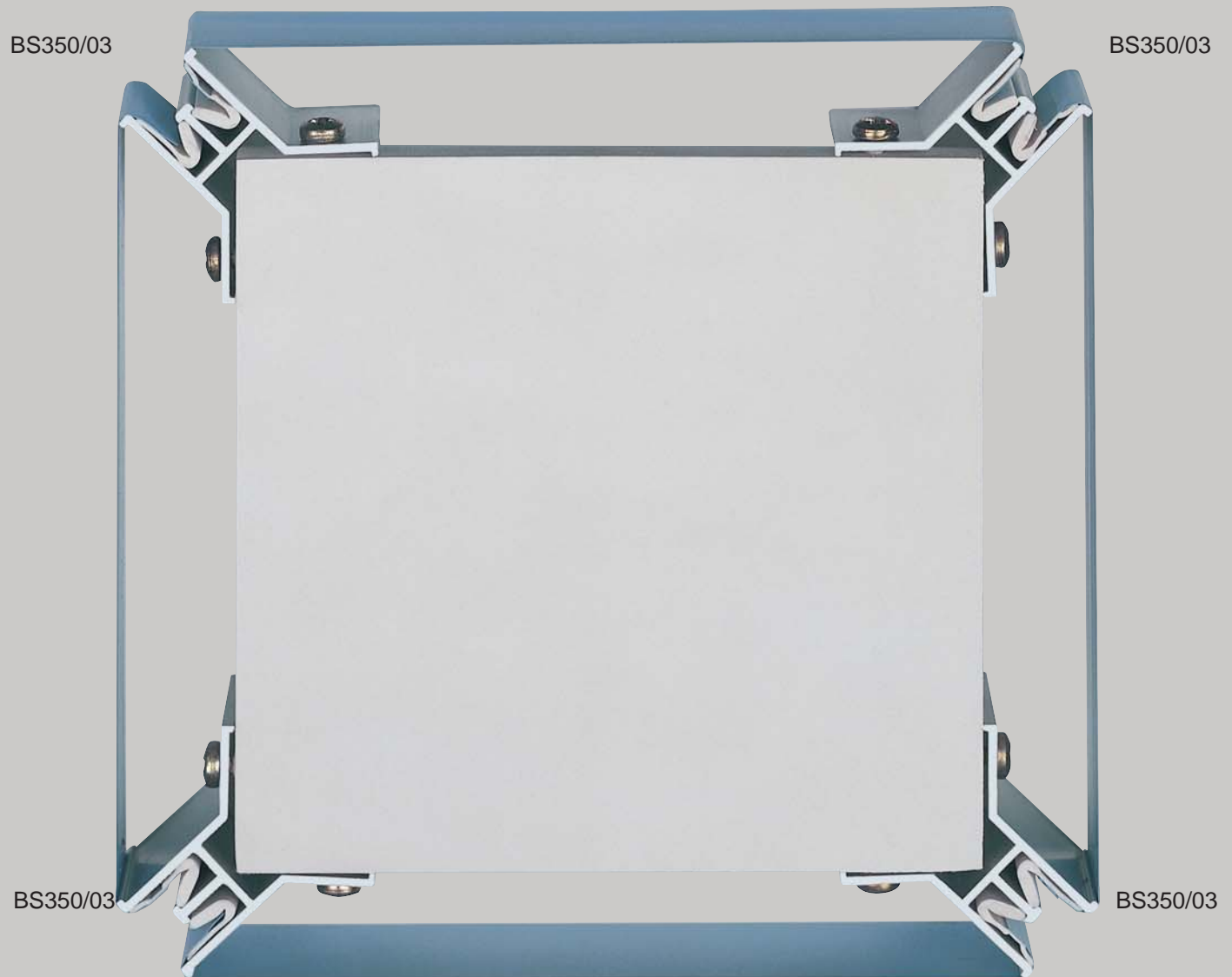



BS350/66

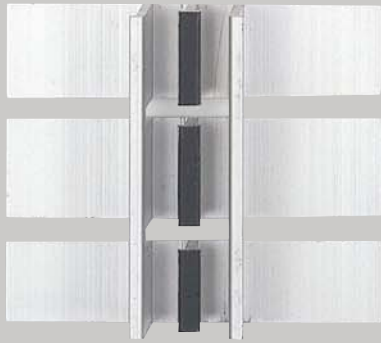

BS350/62



BS350/61



BS350/51



BS355/01



BS355/01

BS355/03

BS350/15



BS350/202

BS350/151

BS350/11

BS350/11



BS355/04

BS350/11



B317/03

B317/03



BS355/04

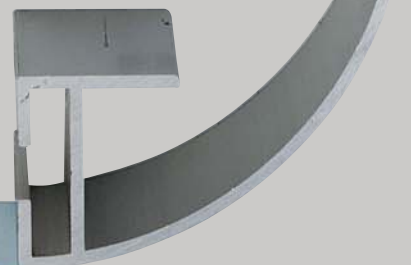
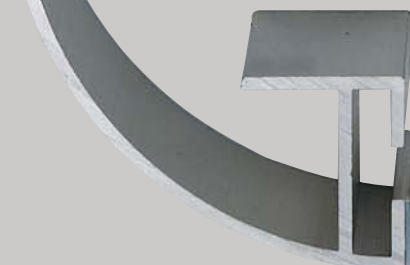
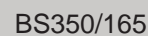
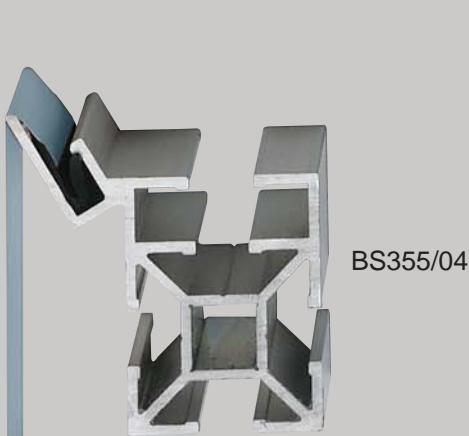
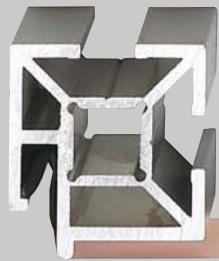



BS355/163

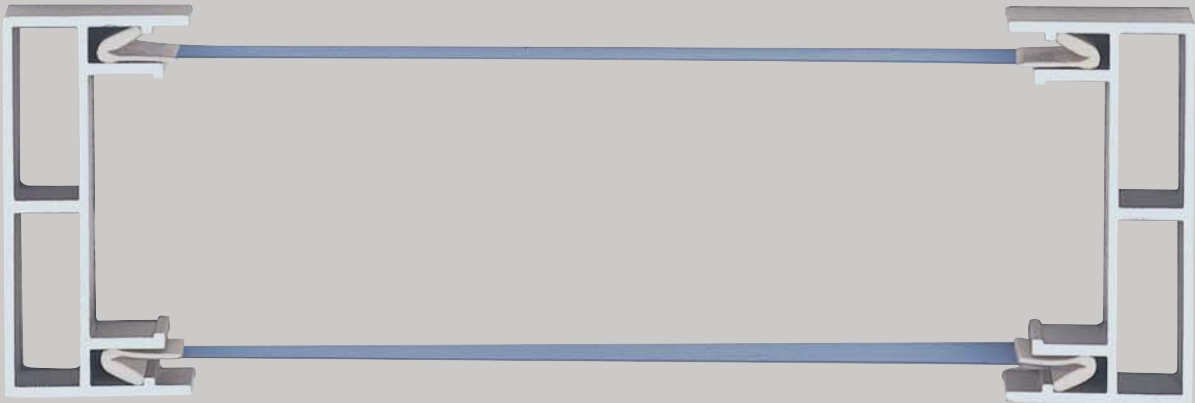

BS355/163

BS355/082



BS355/081

BS355/081

BS355/08

BS355/08

BS355/08

BS355/08

BS355/08

BS355/05

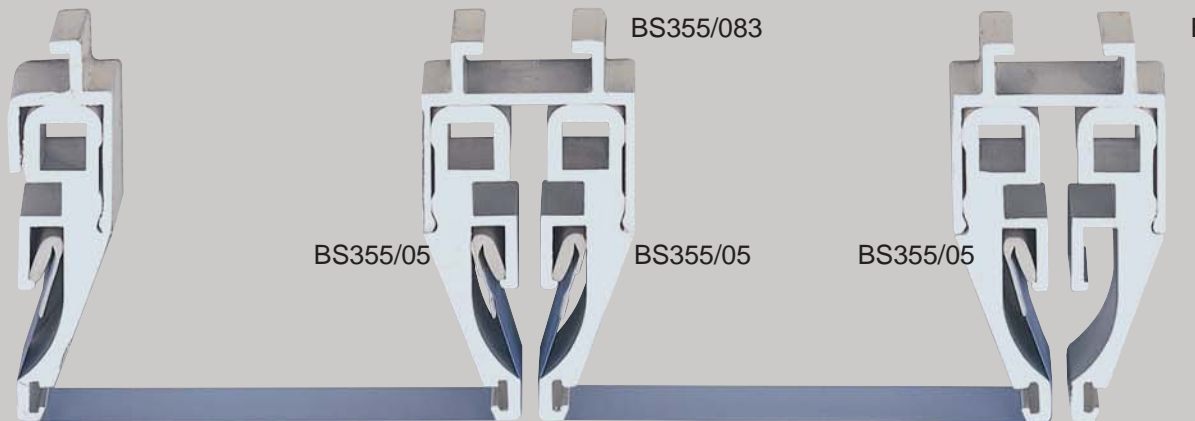

BS355/083

BS355/083

BS355/05

BS355/05

BS355/05

BS355/05

BS350/11

B317/03



BS355/15



BS355/15

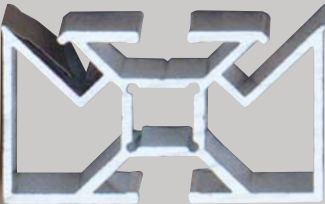
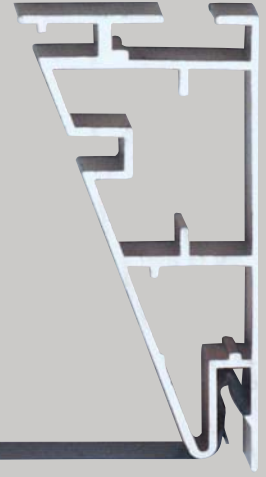

BS355/18



BS355/18

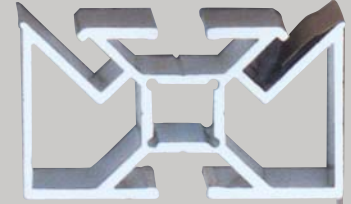

BS355/18

BS355/17



BS355/17

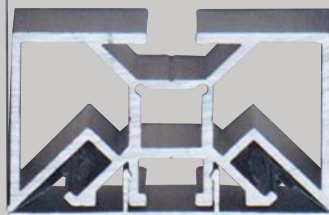

BS355/17

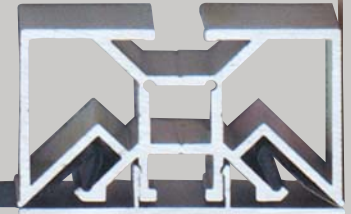

BS355/171



BS355/171

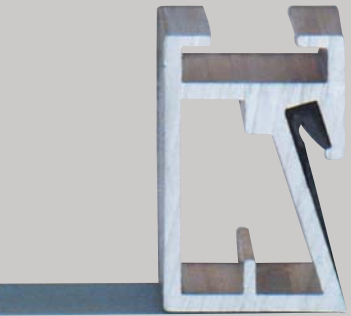

BS355/55

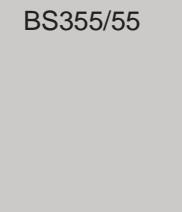

BS355/55

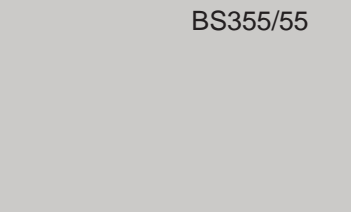



BARRISOL®

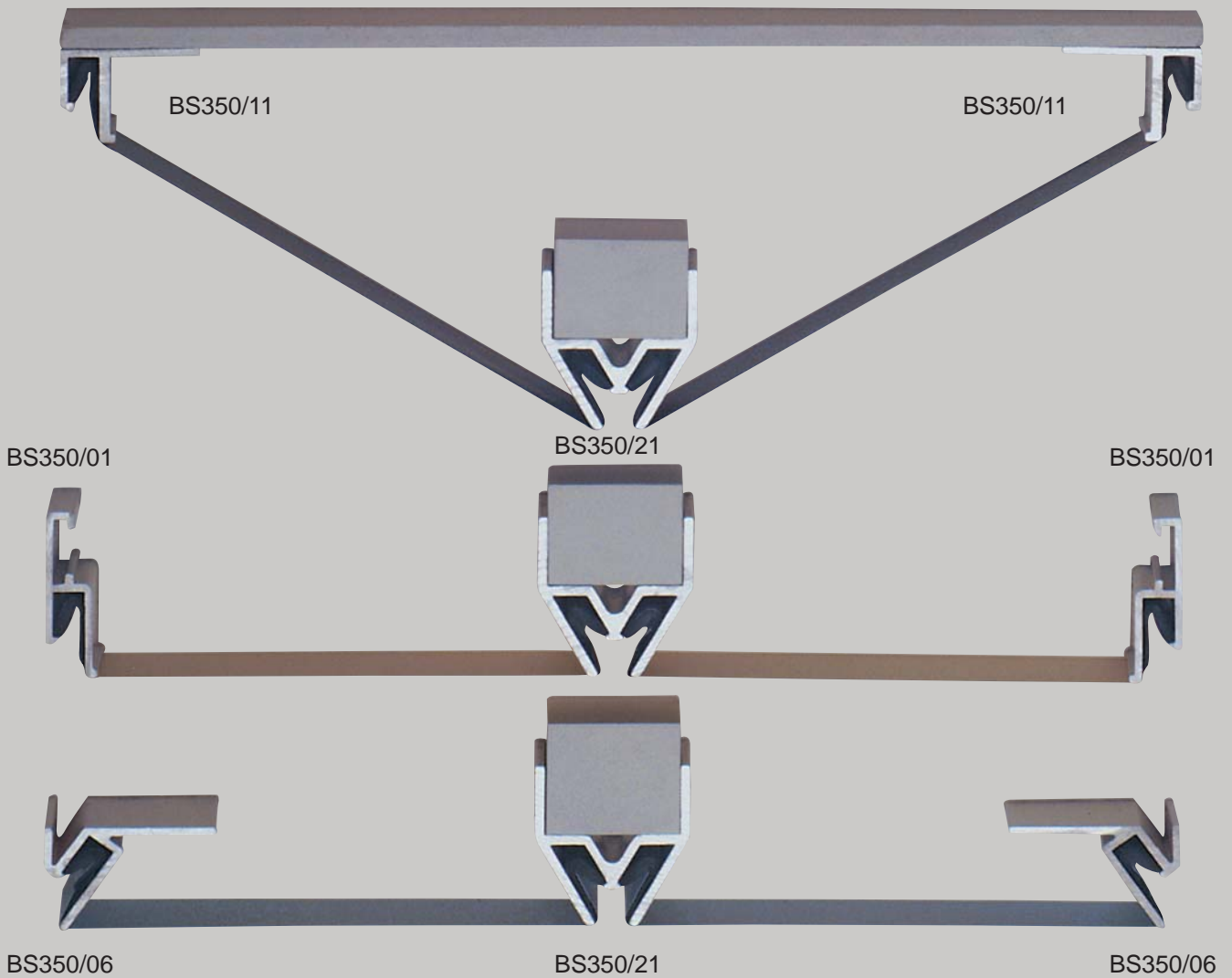
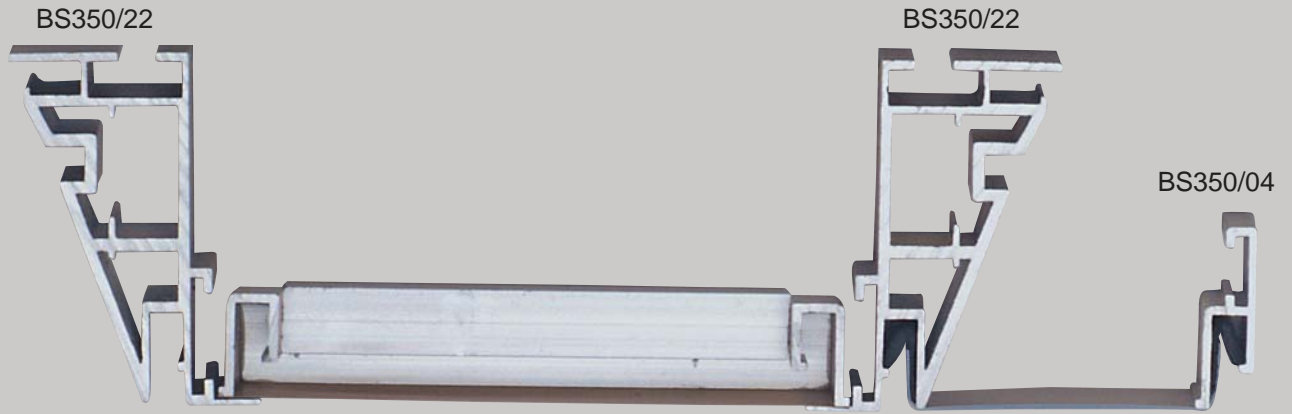



Belgium 2004



Canada 2003



Allemagne 2002



Allemagne 2002



Rép. Tchèque 2001



Roumanie 2001



Pologne 2001



Pologne 2000



Allemagne 2000



Canada 1999



USA 1998



Canada 1997



Chili 1997



Chine 1996



Australie 1996



Chine 1995



Rép. Tchèque 1995



Rép. Tchèque 1993



France 1991



France 1991



Suisse 1990



France 1990



France 1985



France 1984



France 1983



France 1975



 **BARRISOL®**



PRODUCT OF BARRISOL-NORMALU S.A.S. - 68680 KEMBS - FRANCE

Tél. : +33 (0)3 89 83 20 20 - Fax : +33 (0)3 89 48 43 44

E-mail : mail@barrisol.com

www.barrisol.com



COPYRIGHT © 2004 (2007) NORMALU S.A.S. - Tous droits réservés.

- Gyss Imprimeur Obernai - 271730 - 3 000ex - 04/2008

Réf. B813/02